

Chicken Check: On NXP RFID Technology

First Draft Ideas

- RFID bird ringing, bird banding, tagging
- 13.56 MHz HF band (not LF nor UHF)
- <https://learn.adafruit.com/adafruit-pn532-rfid-nfc?view=====all>

About RFID

- <https://www.rfid-grundlagen.de/>
- <https://www.smart-tec.com/de/faq>

HF RFID Technology (13.56 MHz)



- Matt Rose and Jon Kurtz (2016): [NFC - A Closer Look](#)
Future Electronics, original [download](#)

ISO 14443: Proximity Communication (typ. range: 7-15 cm)

1. **Frequency:** Both ISO 14443 and ISO 15693 operate at **13.56 MHz**.
2. **Purpose:** ISO 14443 is commonly used in contactless smart cards and NFC-enabled devices.
3. **Read Range:** ISO 14443 has a shorter read range of **7-15 cm** (approximately 2.8-5.9 inches).
4. **Data Transfer Rate:** It offers a higher data transfer rate with a **106 kbps** Baud rate.
5. **Applications:** ISO 14443 is suitable for financial transactions, access control, parking solutions, and attendance systems².

ISO 15693: Vicinity Communication (typ. range: < 100 cm)

1. **Purpose:** ISO 15693 defines the communication protocol for RFID tags operating at **13.56 MHz**.
2. **Read Range:** ISO 15693 provides an extended read range of **up to 1 meter** (approximately 3.3 feet).
3. **Data Transfer Rate:** It has a slower data rate with a **26 kbps** Baud rate.
4. **Applications:** ISO 15693 is useful for applications like inventory management, asset tracking, and libraries¹⁵.

In summary, ISO 14443 is ideal for short-range applications like wireless payments, while ISO 15693 suits scenarios where longer read distances are necessary. □□□¹²

Source: Conversation with Copilot, 30/06/2024

(1) NFC Reader Guide - Shop NFC. <https://bing.com/search?q=iso+14443+vs+iso+15693>.

(2) The difference between ISO15693 and ISO14443 - RFID Card.

<https://www.rfidcard.com/the-difference-between-iso15693-and-iso14443/>.

(3) Understanding the ISO15693 Protocol: An In-depth Look.

<https://www.rfidlabel.com/understanding-the-iso15693-protocol-an-in-depth-look/>.

(4) NFC Reader Guide - Shop NFC. <https://www.shopnfc.com/en/content/31-nfc-reader-guide>.

(5) What is ISO/IEC 15693? RFID Communication Standard for HF and NFC.

<https://www.encstore.com/blog/5722-what-is-iso-iec-15693-rfid-communication-standard-for-hf-and-nfc>.

Differences between ISO/IEC 15693-26 and ISO/IEC 15693-53 (Collected by COPILOT)

ISO/IEC 15693-26:

1. **Modulation Scheme:** ISO/IEC 15693-26 uses a subcarrier frequency of 423.75 kHz.
2. **Data Rate:** The data rate for ISO/IEC 15693-26 is **26.48 kbps**.
3. **Application:** This variant is commonly used in applications such as inventory management, asset tracking, and library systems.
4. **Read Range:** The read range is typically up to 1 meter (approximately 3.3 feet).

ISO/IEC 15693-53:

1. **Modulation Scheme:** ISO/IEC 15693-53 uses a subcarrier frequency of 847.5 kHz.
2. **Data Rate:** The data rate for ISO/IEC 15693-53 is **53.98 kbps**.
3. **Application:** It is also used for inventory management, asset tracking, and similar applications.
4. **Read Range:** Similar to ISO/IEC 15693-26, the read range is up to 1 meter.

In summary, both variants are part of the ISO/IEC 15693 standard and share similar use cases. The main difference lies in their modulation frequencies and data rates. ☐☐☐

Source: Conversation with Copilot, 30/06/2024

GAO RFID

- [13.56_MHz_HF_High-powered_RFID_Reader_233016.pdf](#)
- Range: up to 90 cm with single antenna
- Speed: up to 60 readings per second
- Separation: 300 tags at once

NXP NFC Solutions



- [NXP Semiconductors Near Field Communication \(NFC\) Solutions](#), Intro, Overview
- [NXP Recommended NFS Reader ICs](#)

Recommended NFC Reader ICs

Part Number	NFC Modes	Protocols*	Output Power	LPCD* performance	Contact Reader ISO7816	RF transmitter supply voltage	Temp range	Integrated MCU
PN7220 <small>NEW</small> EMV LI compliant NFC controller with NCI interface supporting EMV and NFC Forum applications	Reader/Writer	A, B, F, V	2 W	++	-	2.4 to 6 V	-40 to +105°C	-
PN7642 Programmable NFC microcontroller	Reader/Writer, CardEmulation	A, B, F, V, I	2 W	+++	With connected TDA8035	2.4 to 6 V	-40 to +105°C	M33 with 180K Flash memory, hardware accelerators for symmetric and asymmetric crypto, secure key store
PN7462 Family Programmable NFC microcontroller	Full NFC	A, B, F, V, I	1.3 W	++	✓	3 to 5.5 V	-40 to +85°C	Cortex-M0 160 kB
PN7160 NFC controller with integrated FW*	Full NFC	A, B, F, V	1.3 W	++	-	2.7 to 5.25 V	-25 to +85°C	Cortex-M0 fixed FW
PN5190 Full NFC frontend, High RF output	Full NFC	A, B, F, V, I	2 W	+++	-	2.4 to 6 V	-40 to +105°C	-
PN5180 High-performance full NFC frontend	Full NFC	A, B, F, V, I	1.3 W	++	-	2.7 to 5.5 V	-30 to +85°C	-
CLRC663 plus family High-performance multiprotocol reader frontend	Reader/Writer	A, B, F, V, I	1.9 W	+++	-	2.5 to 5.5 V	-40 to +105°C	-

*Protocols: A: ISO/IEC 14443A; B: ISO/IEC 14443B; F: FeliCa™; V: ISO/IEC 15693 (Vicinity); I: ISO/IEC 18000-3M3 (ICODE® ILT)
 LPCD: Low-Power Card Detection
 FW: Firmware
 Non-standard data rates* for NTAG 5 support: PN7462 ~V+, PN5190 ~V++
 *~V+: 106Kbit; ~V++: 212 Kbit

Image Source: [NXP Recommended NFS Reader ICs](#)

Antenna Design

-  **NXP NFX Antenna Design Hub (Tool)**
- [AN13219 - PN7160 antenna design and matching guide](#)

NXP PN5190

- **NXP PN5190 MAIN PAGE**
-  **2 Watt output power**
- Internal DC/DC boost converter
- Max output power RF from a single 3.3V source
- [PN5190 Product Sheet](#)
- [AN12550 - PNEV5190B evaluation board quick start guide](#)

NXP CLRC663 plus (CLRC66303HN)

High performance multi-protocol NFC frontend



<https://www.nxp.com/products/rfid-nfc/nfc-hf/nfc-readers/clrc663-iplus-i-family-high-performance-nfc-frontends:CLRC66303HN>

<input type="text"/>	<input type="text"/>
Source: NXP CLRC663 product page	
<input type="text"/>	<input type="text"/>
Evaluation Board CLEV6630B (NXP) Development Kit OM26630FDKM (NXP, including CLEV6630B)	

-  [NXP CLRC663 Product Page](#)
- Chip Name: **CLRC66303HN** (I_T(max) 350-500 mA, up to 2 Watts)
- Eval Board Name: **CLEV6630B**
- Dev Kit Name: **OM26630FDKM** (includes CLEV6630B)
- Datasheet **CLRC663**: [NXP CLRC663 - High performance multi-protocol NFC frontend CLRC663 and CLRC663 plus](#)
- Datasheet **SLRC610**: [NXP SLRC610 - High-performance ICODE frontend SLRC610 and SLRC610 plus](#)
- [AN11022 CLRC663 evaluation board quick start guide](#)
- [AN12657 Using the RC663 without library](#)

NXP PN5180

<input type="text"/>	
OM25180FDK Dev. Kit + Extras from NXP	NNEV5180BM product picture by Farnell .

-  [NXP PN5180 Product Page](#)
- Chip Name: **PN5180B** (I_T(max) 250 mA) (PN5180A0HN???)
- Eval Board Name: **PNEV5180B**
- Dev Kit Name: **OM25180FDKM** (includes PNEV5180B)
- [NXP NFC Antenna Tool](#)
-  Datasheet PN5180, **C3,C4** (Rev. 4.1, 2023-03-13): [NXP PN5180A0xx/C3,C4 Rev. 4.1](#)
- Datasheet PN5180, **C1,C2** (Rev. 3.6, 2018-05-07): [NXP PN5180A0xx/C1/C2 Rev. 3.6](#)



PN5180 Application Notes

- [AN11744 PN5180 Evaluation board quick start guide](#)
- [UM10954 PN5180 SW quick start guide](#)
- [AN11906 Starting a product development with PN5180](#)
- [AN12650 Using the PN5180 without library](#)
- [AN12810 How to use the NanoVNA for the NFC reader antenna design](#)
- [AN11740 PN5180 Antenna design guide](#)
This document describes the “standard” antenna design and tuning related to the PN5180.
- [AN11741 How to design an antenna with DPC](#)
This document describe the “symmetrical” antenna design, which is must be used together with the Dynamic Power Control (DPC), and therefore is called DPC antenna tuning
- [AN11742 - Dynamic Power Control for \(DPC\)](#)
This document (AN11742) describes the Dynamic Power Control (DPC) feature of the PN5180 and the PN7462 and how to use it. It describes how to control the wave shapes using the TX Shaping feature in combination with the DPC. It shows examples with the PNEV5180B and the NFC Cockpit.
-  [NXP NFC Online Antenna Design Tool](#)

PN5180 Arduino Libraries

- <https://github.com/ATrappmann/PN5180-Library>
- <https://github.com/L4M0S/PN5180-Library-14443>
- <https://github.com/playfultechnology/arduino-rfid-PN5180>
- <https://github.com/playfultechnology/PN5180-Library>

NXP PN532

Adafruit RFID/NFC PN532 Breakout

Adafruit PN532 RFID Breakout Board with ESP32

- [adafruit_pn532](#)
- NXP PN532 Datasheet: [PN532_C1.pdf](#)

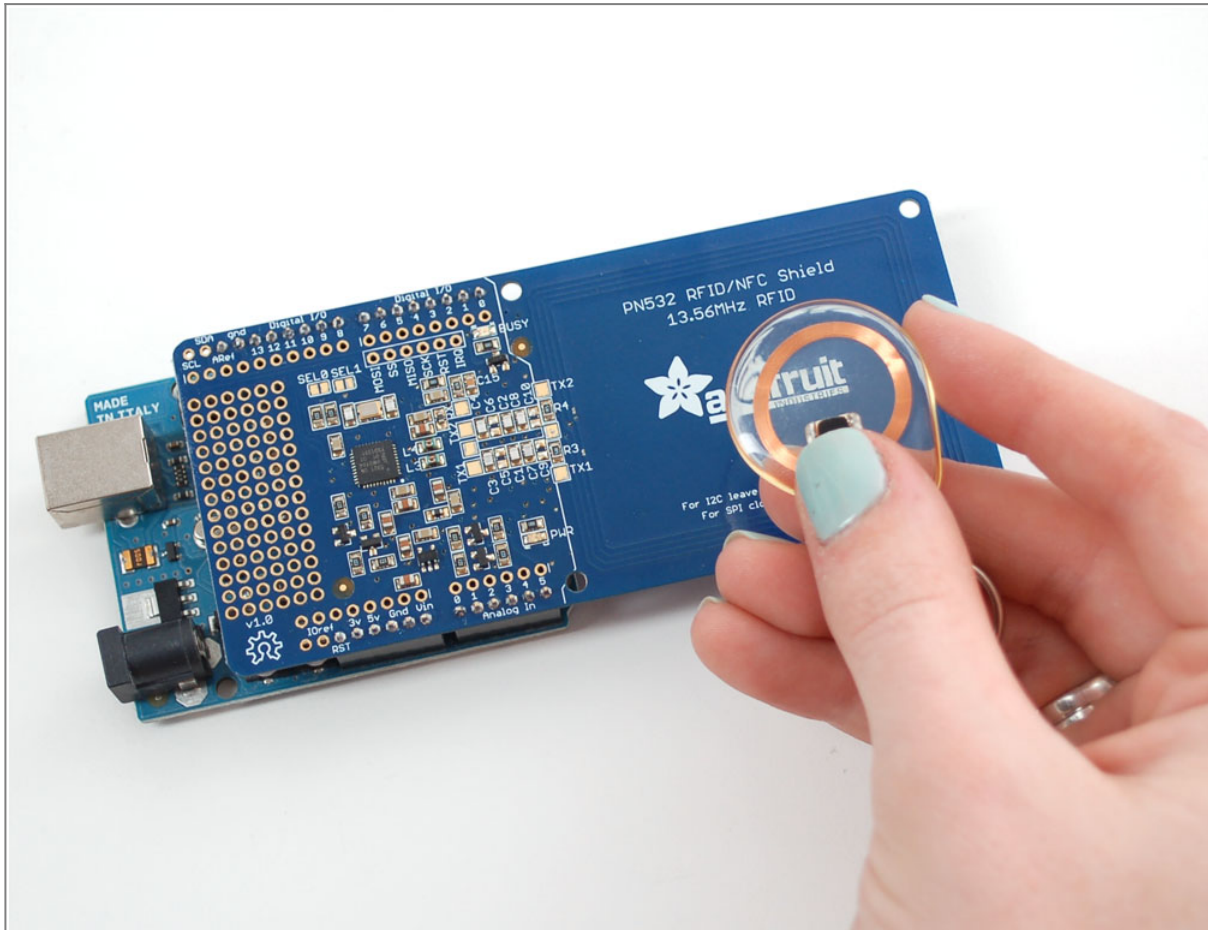

Source: <https://learn.adafruit.com/adafruit-pn532-rfid-nfc?view=all>

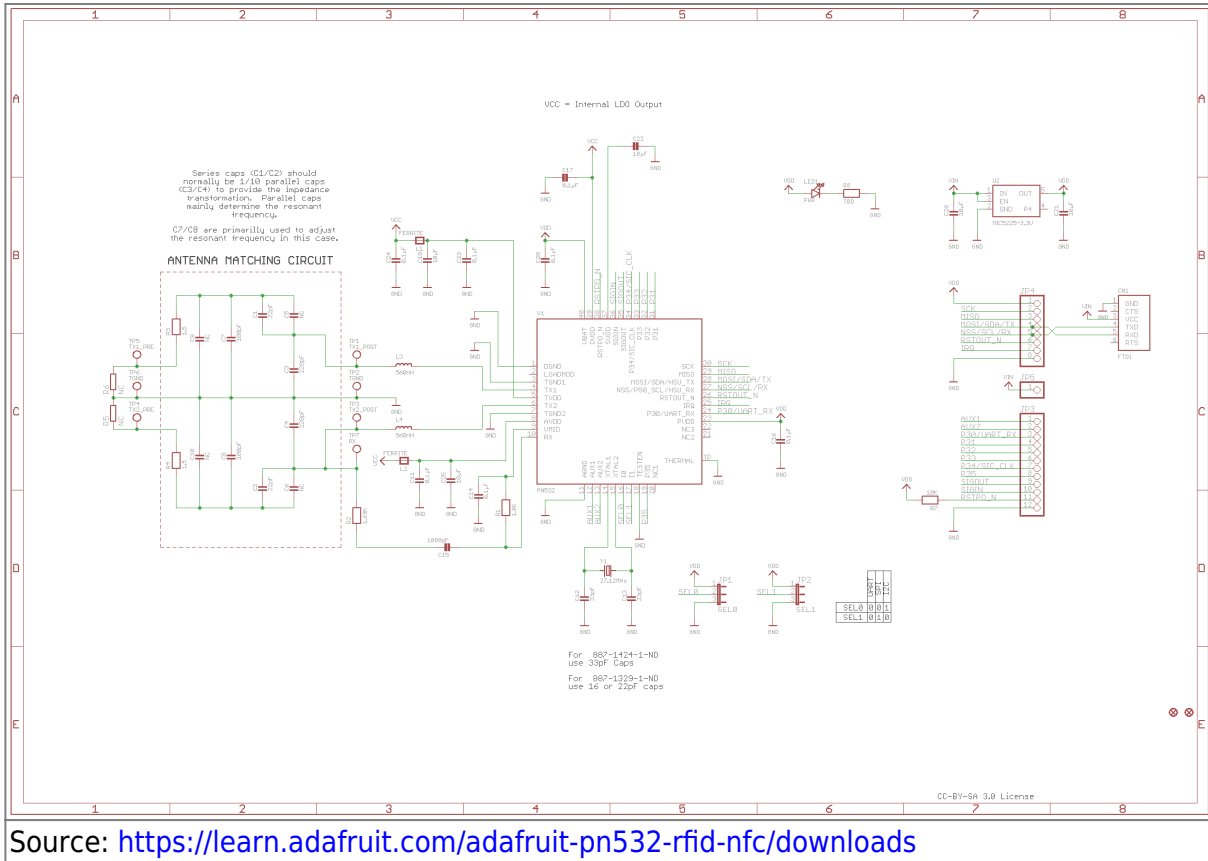

Source: <https://learn.adafruit.com/adafruit-pn532-rfid-nfc/downloads>

Serial Interface Signals

SPI	I2C	UART
SCK		
MISO		
MOSI	SDA TX	
NSS	SCL RX	
Common		
IRQ		
RSTOUT_N		
VDD/3.3V		
GND		

Adafruit PN532 Antenna Design

- Adafruit: https://cdn-shop.adafruit.com/datasheets/PN532_AntennaDesign_v1.0.pdf
-  NXP AN1445 + Excel Sheet to optimize antenna: https://www.nxp.com/docs/en/application-note/AN1445_An1444.zip

PN532 Module V3 by Elechouse (5V, red board)

This is the cheap version (the red board with 8 + 4 pin headers / connectors) you still can buy everywhere. Drawback: Only the 5V is exposed to the connector and not the 3.3V output. The board has to be modified to be usable with a 3.3V voltage source, e.g. by desoldering the voltage regulator

and building wire bridge from 3.3V to the power pin on the connector (originally named 5V).

- [PN532_Manual_V3.pdf](#)
- <https://github.com/elechouse/PN532>



Other version of the red board (3.3V, 5V)

Wiki: http://wiki.sunfounder.cc/index.php?title=PN532_NFC_RFID_Module



Instructables: <https://www.instructables.com/HackerBox-0072-Tagger/>

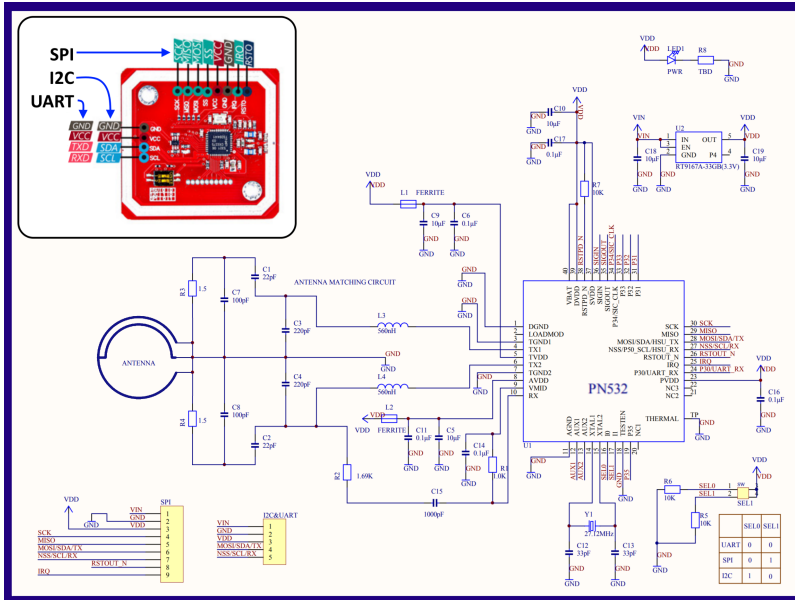

PN532_Schematic.pdf

Terminology

Bird ringing is the term used in the UK and in some other parts of Europe and the world. Bird banding is the term used in the US. Organised ringing efforts are called ringing or banding schemes, and the organisations that run them are ringing or banding authorities. (Birds are ringed rather than rung) Those who ring or band are known as ringers or banders, and they are typically active at ringing or banding stations.

https://en.wikipedia.org/wiki/Bird_ringing

From: <https://student-wiki.eolab.de/> - **HSRW EOLab Students Wiki**

Permanent link: https://student-wiki.eolab.de/doku.php?id=amc:ss2024:chicken_check:nxp_rfid:start&rev=1725035430

Last update: **2024/08/30 18:30**

