

Air Quality and Noise Levels in Different Parts of Kamp-Lintfort City

1. Introduction

The German Environment Agency (UBA) and the European Environment Agency (EEA) reported that tens of thousands of people die because of high air pollution of early deaths and Year of Life Lost due to premature mortality. The dominant air pollutants with the highest impact on the European citizens' health are Particulate Matter (PM), nitrogen dioxide (NO₂), and ozone (O₃). Because of its coal mining industry, North Rhine-Westphalia (NRW) has a long history of air pollution. Additionally, with its high population density of 1,170 inhabitants per square kilometer, NRW state corresponds to one of the densest areas and, therefore, one of Germany's highest traffic areas. The NO₂ emissions exceed limiting values in several cities in NRW (L. Petry et al., 2020).

Air quality is essential when deciding where to live and pursue a life with good living standards. In particular, serious health issues are caused by air pollution, such as neurological, cardiovascular, and respiratory diseases. Noise coming mainly from dense traffic, industrial and construction activities can cause a significant impact on people's health. Kamp-Lintfort (KL) is a university town in NRW with a large community of academics and students. It is crucial as part of the scientific community to monitor the living quality in KL, particularly in residential areas. Low air quality levels or high levels of noise could affect students' brain functionality and performance at the university.

This project aims to measure mainly the concentrations of carbon dioxide (CO₂) and the sound intensity in three different locations in Kamp-Lintfort. The first one is Meisenweg, the second one is Moerserstraße, and the third one is Kamperdickstraße. Assumably, the three areas are selected in a way that would give one extreme case with high concentrations of the chosen toxic gas and high noise level, the second with medium levels, and the third with low ones. For that purpose, two different sensors are utilized and a microcontroller to read the resultant values and communicate data, hence drawing out well-derived conclusions.

2. Materials Description

- 1× Arduino Uno R3
- 1× ESP-32 Microcontroller
- 1× MQ-135 gas sensor
- 1× LM-393 sound sensor
- 1× LCD display with I2C adapter (16 chars × 2 lines)
- 2× LED lights
- 2× 220 Ohm Resistors
- 1× 10k Ohm Resistor
- Jumper/ connecting wires
- 1× White breadboard

MQ135 Sensor

https://www.electronicoscaldas.com/datasheet/MQ-135_Hanwei.pdf

<https://microcontrollerslab.com/interfacing-mq-135-gas-sensor-arduino/>

https://www.teachmemicro.com/mq-135-air-quality-sensor-tutorial/#MQ-135_Acetone_Sensor_with_Arduino

MQ135 sensors are commonly used in air quality control equipment for buildings/offices. They are

suitable for detecting NH₃, NO_x, alcohol, Benzene, smoke, CO₂, etc. MQ135 is selected to measure the air quality in residential areas in KL for several reasons: an affordable, easy-to-use sensor that measures the concentration of various toxic gases and has decently high sensitivity and fast response. Moreover, its operation is based on a simple drive circuit, making it suitable for controlling air quality levels on small scales like our project.

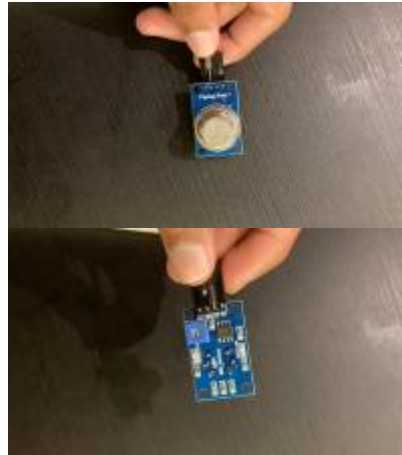

Figure 3: MQ135 Air Quality

Sensor.

Source: AZ-Delivery Vertriebs GmbH, Bräugasse 9, 94469, Deggendorf, Deutschland

Specifications: The working voltage is 5 V, and the analog output voltage is 0-4.2V. MQ135 senses the air quality via a chemical-sensitive element covered by a steel exoskeleton. This element is subjected to a preheating current, where the gases to be measured later get ionized and absorbed. The preheating time required is around 12-24 hours. After absorption of these gases, the resistance of the sensing substance changes, which in turn changes the amount of current going out. When the gas concentrations transcend specific safety limit values, an LED light is illuminated as an alarm.

The wire connections in the circuit are as followed:

- Arduino Analog Output pin A0 with the MQ135 Sensor Analog Output
- Arduino 5V pin with the MQ135 Sensor Vcc
- Arduino Ground (GND) pin with the MQ135 sensor Ground (GND)

LM393 Sensor

<https://www.electronicshub.org/interfacing-sound-sensor-with-arduino/>

<https://components101.com/modules/lm393-sound-detection-sensor-module>

<https://randomnerdtutorials.com/guide-for-microphone-sound-sensor-with-arduino/>

<https://5.imimg.com/data5/CY/QV/MY-1833510/sound-detection-sensor.pdf>

A sound sensor with an LM393 comparator is used to measure sound intensity in the three selected areas in Kamp-Lintfort in this project. The sensor consists mainly of a microphone, a voltage comparator IC LM393, a sensitivity adjustment potentiometer, two LEDs (one power LED and one OUT LED), and a few other passive components (resistors and capacitors). The sound sensor module is a low-cost electronic sensor, and its circuit is easy to build. Moreover, it has an adjustable sensitivity, makes its operation flexible, and can be used in security and monitoring applications.

The microphone, a capacitor-based electronic component, detects the sound wave and sends

electrical pulses to the circuit board. The potentiometer is used to adjust the sensor's sensitivity. At the same time, the voltage comparator IV LM393 processes the signal by comparing it to the threshold preset by the potentiometer. Thus, the digital output is obtained (Digital Output (0 or 1)). By rotating the trimmer knob of the potentiometer clockwise (counterclockwise), the sensor's sensitivity decreases (increases).

Specifications: The working voltage is 3.3-5V.



Figure 4: LM393 Microphone Sound

Sensor

Source: The most complete starter kit UNO R3 Project from Rhein-Waal Hochschule

The wire connections in the circuit are as followed:

- Arduino Digital Output pin 12 with the LM393 Sensor Digital Output
- Arduino 5V pin with the LM393 Sensor Vcc
- Arduino Ground (GND) pin with the LM393 sensor Ground (GND)

LCD Screen Paired with I2C

<https://core-electronics.com.au/tutorials/use-lcd-arduino-uno.html>
http://www.handsontec.com/dataspecs/module/I2C_1602_LCD.pdf



Figure 5: Liquid Crystal Display (LCD) screen (16 x 2) paired with I2C

Source: The most complete starter kit UNO R3 Project from Rhein-Waal Hochschule

Liquid Crystal Display is a screen used to display values and data when working with Arduino IDE 1.8.15. It is composed of a liquid crystal inserted between 2 glass pieces, and it reacts when current is applied. A backlight is responsible for showing the values on the screen. The contrast between the values written and the dark background is controlled using the contrast control options by rotating the potentiometer knob.

The I2C or Inter-Integrated circuits make it easier to connect multiple "slaves" to a single master.

Instead of utilizing numerous pins between the Arduino Uno and the LCD, only the following I2C pins are connected with the Arduino Uno.

- SDA pins
- SCL pins
- GND
- VCC to a 5V output in the Arduino Uno

Meanwhile, the LCD should ideally be soldered to the I2C. But in this project, the LCD and I2C were connected directly on the breadboard.

3. Setup Diagram

After testing each sensor alone, they are all set up together with the help of an Arduino white breadboard. The breadboard is powered by a 5V voltage supply on the positive red line, whereas the ground is the negative blue line. Since more than the pins provided by the Arduino microcontroller board were needed to suffice sensors, the LCD and its adapter, and alarm systems (with the LEDs and the buzzer), The white breadboard is used. For better visualization, see figure 6.

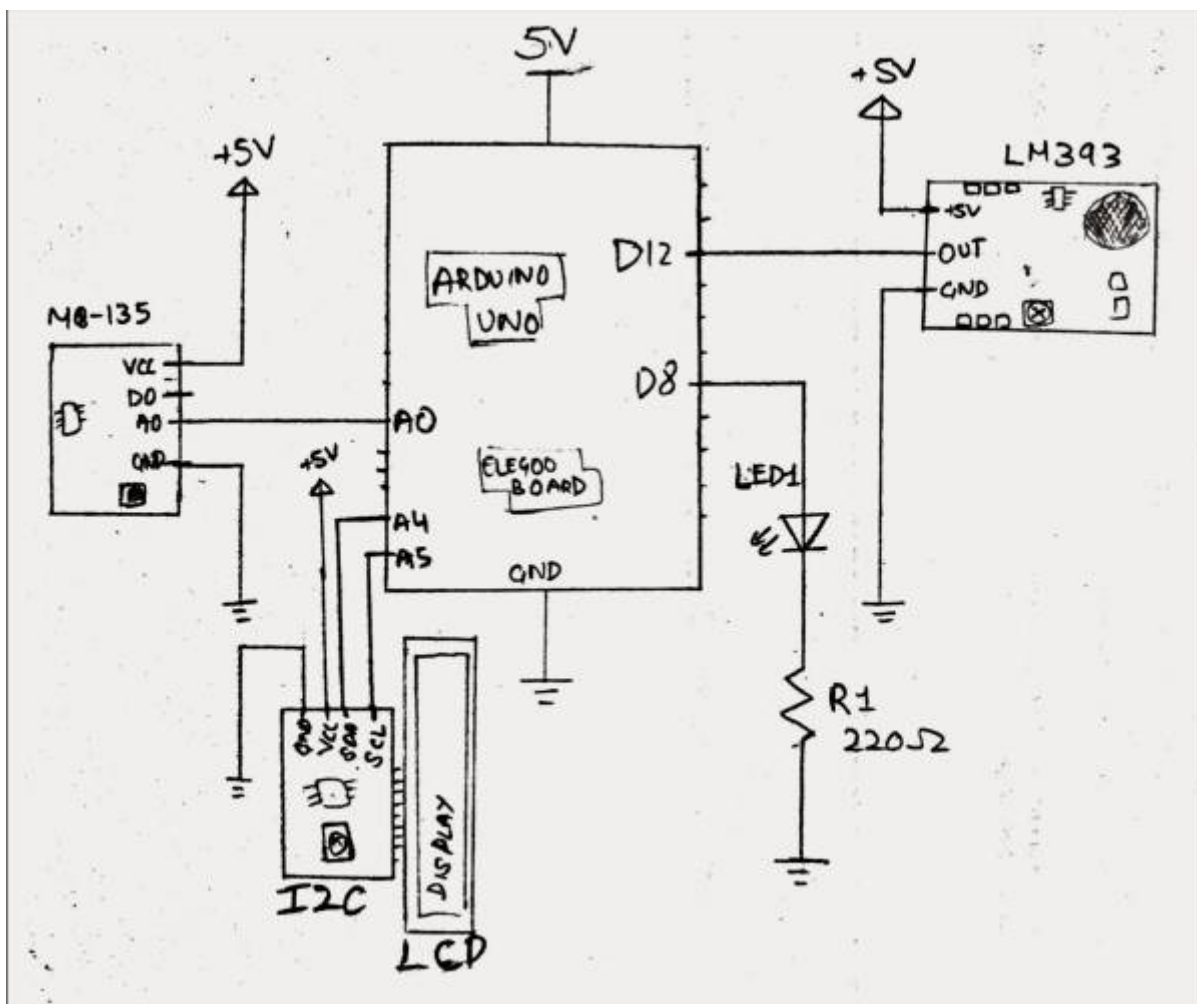

Figure 6: Circuit Diagram Schematic of the Connections between the sensors MQ135 and LM393.

4. Software

<https://www.youtube.com/watch?v=SCXteaUVICw>

<https://www.youtube.com/watch?v=PYkzJQhFNIA>

<https://www.google.com/url?q=https://www.google.com/url?q%3Dhttps://www.electronicclinic.com/co2-concentration-co2-ppm-or-co2-levels-using-mq135-sensor-arduino/>

<https://arduino-tutorials.net/tutorial/drawing-sound-sensor-data-on-serial-plotter>

Additional Libraries required:

The open-source Arduino Software (IDE 1.8.15) is used to write the code, upload it to the Arduino board and run it. The MQ135 library is uploaded to the code using the Library Manager Tool to communicate with the QM135 air quality sensor. LiquidCrystal_I2C library is uploaded to communicate with the LCD screen.

Sound detection with the LM393 Sensor (See code explained below):

The sensor's wiring is straightforward: its 5V to the Arduino 5V(via breadboard), the GND to Arduino GND (via breadboard), and the OUT of the sensor is connected to Arduino digital input D12. After powering up the sensor to the 5V, the threshold voltage for the IC LM393 comparator is set by rotating the preset knob of the potentiometer. When the sensor microphone detects sound, a large amount of voltage (pulse) is transferred to the input of the IC LM393 comparator. The comparator processes the input by comparing it to the preset threshold voltage. If the input pulse exceeds the threshold, the sensor output will be 1 (HIGH). In contrast, when the sensor does not detect any sound (silence), then a small amount of voltage is transferred to the input of the comparator, which processes the signal, and if the input pulse is lower than the threshold, the sensor output will be 0 (LOW). This means that if the detected sound is loud (high noise), the sensor output goes to HIGH (digital output = 1), while the sensor output goes to LOW (digital output = 0) if the detected sound is less than the preset threshold.

First, the digital output of the sound sensor is checked directly on the serial monitor (laptop), and the sensitivity of the sensor is adjusted to a reasonable level (see figure 7).



Figure 7 : Serial Plotter: Adjustment of the sensor sensitivity using the potentiometer

From:

<https://student-wiki.eolab.de/> - HSRW EOLab Students Wiki

Permanent link:

<https://student-wiki.eolab.de/doku.php?id=amc2021:data:start&rev=1630575733>

Last update: 2023/01/05 14:38



