

Environmental Monitoring Research Project 2021

-  **Intro to Tasmota, IoT, and NIG (NIG: Node-RED, InfluxDB, Grafana)**
- More on **Tasmota** with WEMOS D1 Mini (ESP8266)

Student Pages

1. Problem description

The city of Moers has bought a lot of new trash bins. In order to be able to monitor the filling level of these trash bins, the trash bins have to be equipped with appropriate hardware and software. This project can be seen as a first prototype which goes through the whole process from the collection of the data to the storage and visualization of the data. We use technologies that are also known from the smart city context.

2. Methods and Tools

For our project, we have used LoRaWAN (Low-power wide-area-network), MQTT (MQ Telemetry Transport), TTN (The Things Network), and, Node-RED to efficiently transmit data between devices and the database.

Before we can describe what is LoRaWAN first we need to understand what is LoRa. LoRa is a radio modulation technique that is essentially a way of manipulating radio waves to encode information using a chirped (chirp spread spectrum technology), multi-symbol format. LoRa as a term can also refer to the systems that support this modulation technique or the communication network that IoT applications use.

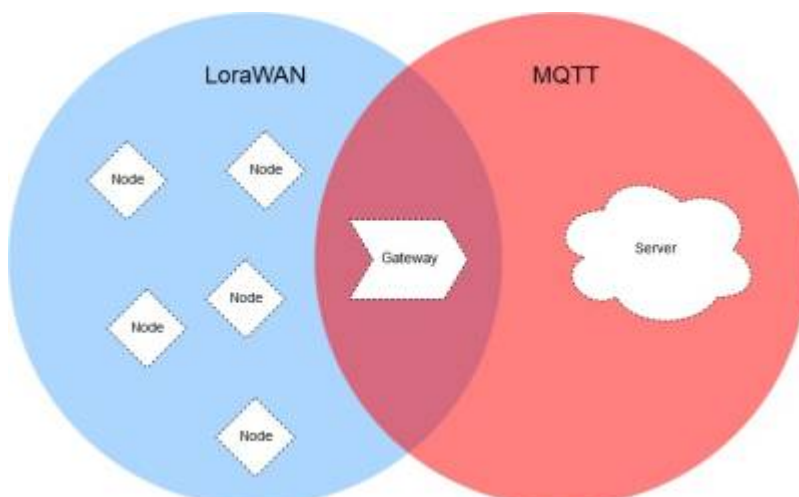

Figure 1: MQTT & LoRaWan

The main advantages of LoRa are its long-range capability and its affordability. A typical use case for LoRa is in smart cities, where low-powered and inexpensive internet of things devices (typically sensors or monitors) spread across a large area send small packets of data sporadically to a central administrator. LoRaWAN is a low-power, wide-area networking protocol built on top of the LoRa radio modulation technique. It wirelessly connects devices to the internet and manages communication between end-node devices and network gateways. The usage of LoRaWAN in industrial spaces and smart cities is growing because it is an affordable long-range, bi-directional communication protocol with very low power consumption — devices can run for ten years on a small battery. It uses the unlicensed ISM (Industrial, Scientific, Medical) radio bands for network deployments.

An end device can connect to a network with LoRaWAN in two ways:

Over-the-air Activation (OTAA): A device has to establish a network key and an application session key to connect with the network. Activation by Personalization (ABP): A device is hardcoded with keys needed to communicate with the network, making for a less secure but easier connection. In our project OTAA is used for the activation of the end device. Before OTAA can be used the end device needs to store its DevEUI, AppEUI and Appkey. The AppEUI is required by the network server which is storing the AppEUI of the end device. The AppEUI is used as a unique identifier for the application server. The AppKey is responsible for the integrity of the message by generating the Message Integrity Code (MIC). AppKey is also stored by the network server. Using MIC a join-request is sent to the network server. The message contains the DevEUI, AppEUI and the DevNonce. DevNonce is a randomly generated number. After that the network server receives the message it checks whether the DevNonce has been used before. The network server uses its stored AppKey to generate its own MIC. If both MICs are the same then the end device is authenticated by the network server and it generates the two session keys, NwkSKey and AppSKey. Then the end device gets its join-accept message from the network server. By using the AppKey and the AppNonce which is part of every joint-accept message the end device can derive the NwkSKey and AppSKey. Besides the two session keys, DevAddr is also stored in the end device. It was created by the network server to identify the device within the network.

It is not necessary to go into all the details of LoRaWAN. However, to better understand this project it is useful to have an understanding of uplink and downlink messages. Uplink messages are messages sent from the device to the network server, which obtains the message through an appropriate gateway. From the network server, the message is forwarded to the correct application server. Downlink messages work the other way around in terms of information flow. The network server forwards a message from an application server to a device via a gateway.

MQTT on the other hand is a lightweight, publish-subscribe network protocol that transports messages between devices. The MQTT protocol defines two types of network entities: a message broker and a number of clients. An MQTT broker is a server that receives all messages from the clients and then routes the messages to the appropriate destination clients. An MQTT client is any device (from a microcontroller up to a fully-fledged server) that runs an MQTT library and connects to an MQTT broker over a network.

Information is organized in a hierarchy of topics. When a publisher has a new item of data to distribute, it sends a control message with the data to the connected broker. The broker then distributes the information to any clients that have subscribed to that topic. The publisher does not need to have any data on the number of locations of subscribers, and subscribers, in turn, do not have to be configured with any data about the publishers.

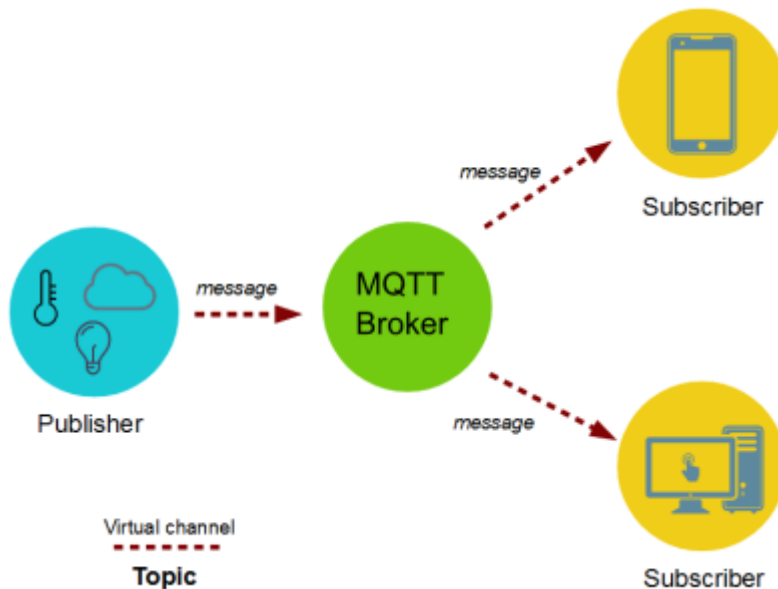

Figure 2: Structure of MQTT

If a broker receives a message on a topic for which there are no current subscribers, the broker discards the message unless the publisher of the message designated the message as a retained message. A retained message is a normal MQTT message with the retained flag set to true. The broker stores the last retained message and the corresponding QoS for the selected topic. Each client that subscribes to a topic pattern that matches the topic of the retained message receives the retained message immediately after they subscribe. The broker stores only one retained message per topic. This allows new subscribers to a topic to receive the most current value rather than waiting for the next update from a publisher.

When a publishing client first connects to the broker, it can set up a default message to be sent to subscribers if the broker detects that the publishing client has unexpectedly disconnected from the broker.

Clients only interact with a broker, but a system may contain several broker servers that exchange data based on their current subscribers' topics.

A minimal MQTT control message can be as little as two bytes of data. A control message can carry nearly 256 megabytes of data if needed. There are fourteen defined message types used to connect and disconnect a client from a broker, to publish data, to acknowledge receipt of data, and to supervise the connection between client and server.

MQTT relies on the TCP protocol for data transmission. A variant, MQTT-SN, is used over other transports such as UDP or Bluetooth.

MQTT sends connection credentials in plain text format and does not include any measures for security or authentication. This can be provided by using TLS to encrypt and protect the transferred information against interception, modification, or forgery.

The Things Network, commonly known as TTN, is an open-source infrastructure aiming at providing a free LoRaWAN network cover. This project is developed by a growing community across the world and is based on voluntary contributions to the project. Their website presents different guides to allow people to deploy gateways in their city to grow the network. These antennas provide both long-range coverage with LoRa and short-range with Bluetooth 4.2. Thanks to the open-source developments on

the source code and on the infrastructure, their coverage is already quite good in big cities and it is spreading in smaller ones.

The Things Network uses MQTT to publish device activations and messages but also allows you to publish a message for a specific device in response.

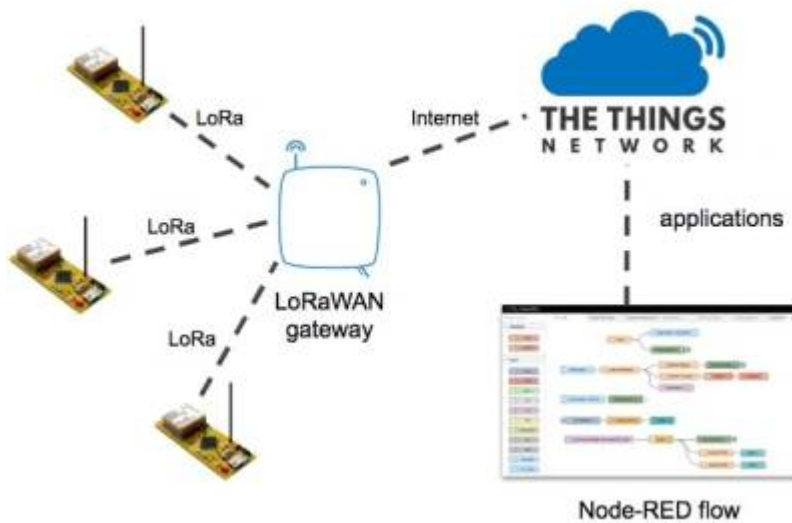

Figure 3: Integration of the relevant technologies

Node-RED is a programming tool for wiring together hardware devices, APIs and online services. It provides a browser-based editor that makes it easy to wire together flows using the wide range of nodes in the palette that can be deployed to its runtime in a single-click. The light-weight runtime is built on Node.js, taking full advantage of its event-driven, non-blocking model. This makes it ideal to run at the edge of the network on low-cost hardware such as the Raspberry Pi as well as in the cloud.

With over 225,000 modules in Node's package repository, it is easy to extend the range of palette nodes to add new capabilities.

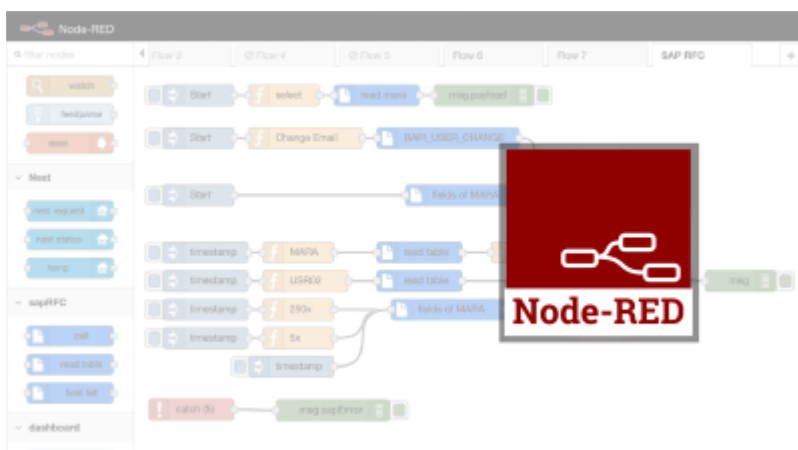

Figure 4: Node-Red

Node-RED consists of a Node.js based runtime that you point a web browser at to access the flow editor. Within the browser you create your application by dragging nodes from your palette into a workspace and start to wire them together. With a single click, the application is deployed back to the runtime where it is run.

The palette of nodes can be easily extended by installing new nodes created by the community and the flows you create can be easily shared as JSON files.

3. Concept

The entire technical stack that is used consists of different layers. On the one hand, we have the microcontroller and the Lora module and the antenna, which are used to forward measurement data. By means of Loawan, these data arrive as uplink messages in the ttn. There, the content of the uplink message is communicated to Node-Red using MQTT. Here, the forwarded uplink message becomes a "msg" that is usual for Node-Red. This is processed with the appropriate nodes and the extracted data is stored in the last step in Node-Red in Postgresql. The data serves as the basis for the visualization in Dash Plotly. Technically we use as microcontroller development board the adafruit feather M0 and two sensors to measure the temperature and distance. This also contains a lora module which works via SPI with the microcontroller and also a corresponding antenna for data transfer. Via IC2 the microcontroller gets the measurement data from the distance sensor VL53L1X.

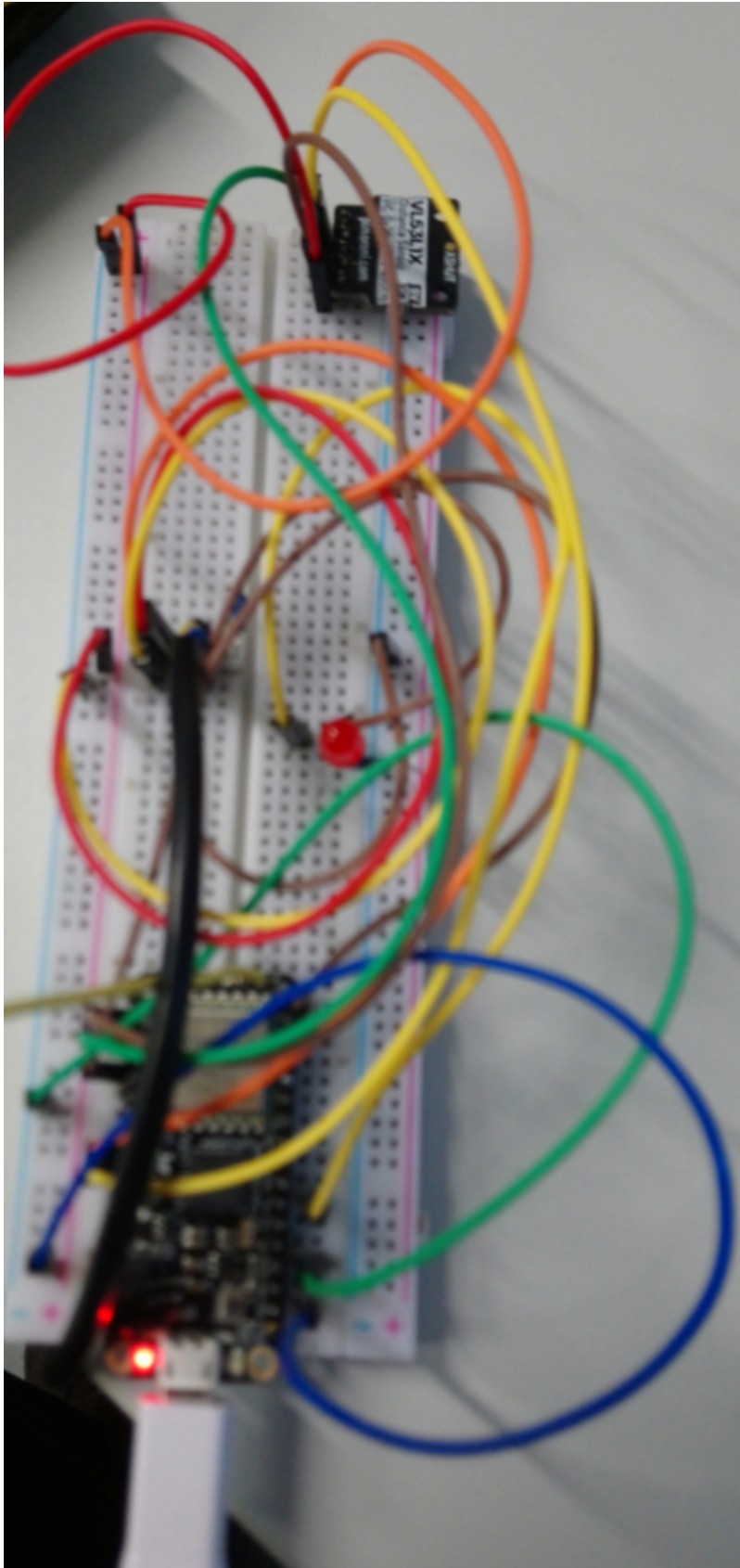

Figure 5: Hardware

4. Implementation

4.1 Prototype and data transfer

4.1.1 TTN

After you have logged in to ttn, you have to click on the “Applications” section. Then you will be redirected and all registered devices will be listed. To register a new device, click on “Add Application”.

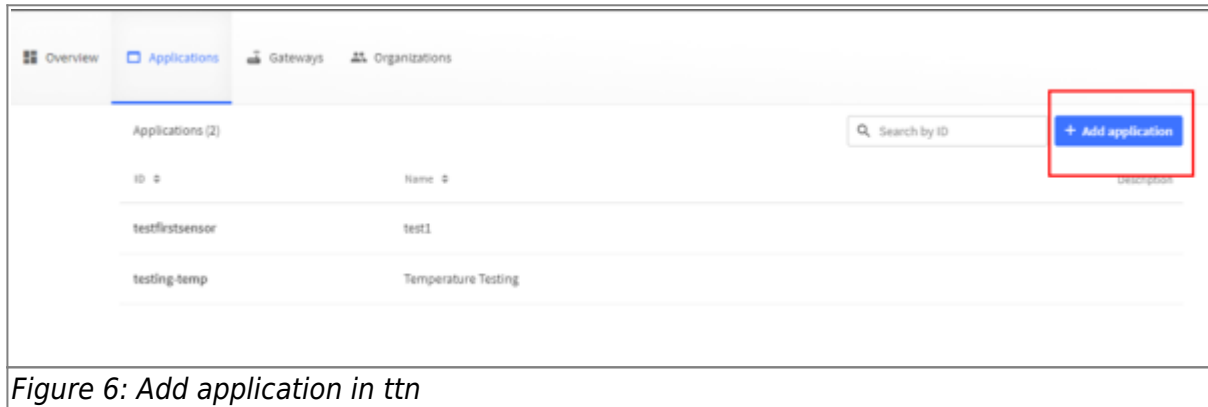

Figure 6: Add application in ttn

Then you can define an ID and name for the application and create the application. It should be noted that the ID must not be an ID that is already assigned and must contain only numbers, lowercase letters and dashes.

Add application

Application ID *

Application name

Description

Optional application description; can also be used to save notes about the application

Create application

Figure 7: Add application (details)

In the next step, a device can be assigned to the application by clicking “Add end Device”. The settings must be entered manually. Ttn automatically assigns an end device id. DevEUI and AppEUI have to be generated. The AppEUI is able to identify the owner of the end device. The DevEUI is used to identify the end device once. In the frequency plan the recommended frequency for Euroe should be chosen. The other parameters for the lorawan version and the regional parameter setting can be found in the datasheet of the used microcontroller.

Register end device

From The LoRaWAN Device Repository

Manually

Frequency plan ⓘ *

Europe 863-870 MHz (SF12 for RX2)

LoRaWAN version ⓘ *

MAC V1.0.2

Regional Parameters version ⓘ *

PHY V1.0.2 REV B

Show advanced activation, LoRaWAN class and cluster settings ▾

DevEUI ⓘ *

70 B3 D5 7E D0 04 D4 F7

Generate

2/50 used

AppEUI ⓘ *

00 00 00 00 00 00 00 00

Fill with zeros

AppKey ⓘ *

F5 76 42 07 34 05 1A 67 36 14 97 7E 86 F0 1D 88

Generate

End device ID ⓘ *

eui-70b3d57ed004d4f7

This value is automatically prefilled using the DevEUI

After registration

- View registered end device
- Register another end device of this type

Register end device

Figure 8: Register device

After the end device is created it can be clicked by user. Then a new page opens which contains all parameters for the end device. Here the data formats for the keys DevEui, AppEui and AppKey can be formatted. It is important to note that the DevEUI and AppEUI keys are entered in the Little Endian Vornat in the script. AppKey is needed in the Big Endian Vornat. This works by pressing “Toggle array formatting” next to the keys. The symbol has been outlined in red in the next figure.

Activation information

AppEUI	0x00, 0x00, 0x00, 0x00, 0x00, 0...	msb ←	<input checked="" type="checkbox"/> <>	
DevEUI	0x70, 0xB3, 0xD5, 0x7E, 0xD0, 0...	msb ←	<input checked="" type="checkbox"/> <>	
Root key ID	n/a			
AppKey	0xF5, 0x76, 0x42, 0x07, 0x3...	msb ←	<input type="checkbox"/> <>	

Figure 9: Change data format

4.1.2 relevant libraries and sketches

The following libraries should be installed under **Tools → Manage Libraries**:

- MCCI LoRaWan LMIC library
- SparkFun VL53L1X 4m Laser Distance Sensor
- DallasTemperature

“MCCI LoRaWan LMIC library” is used for the transmission of the measurements to the ttn. “SparkFun VL53L1X 4m Laser Distance Sensor” is used for the programming of the distance sensor and “DallasTemperature” is used for the programming of the temperature sensor.

The final sketch that was used is just a mix of different example sketches. The following example sketches were used as a inspiration for the final sketch:

- ttn-otaa (MCCI LoRaWan LMIC library)
- Example1_ReadDistance (SparkFun VL53L1X 4m Laser Distance Sensor)
- simple (DallasTemperature)

How to open an example is illustrated in the next figure.

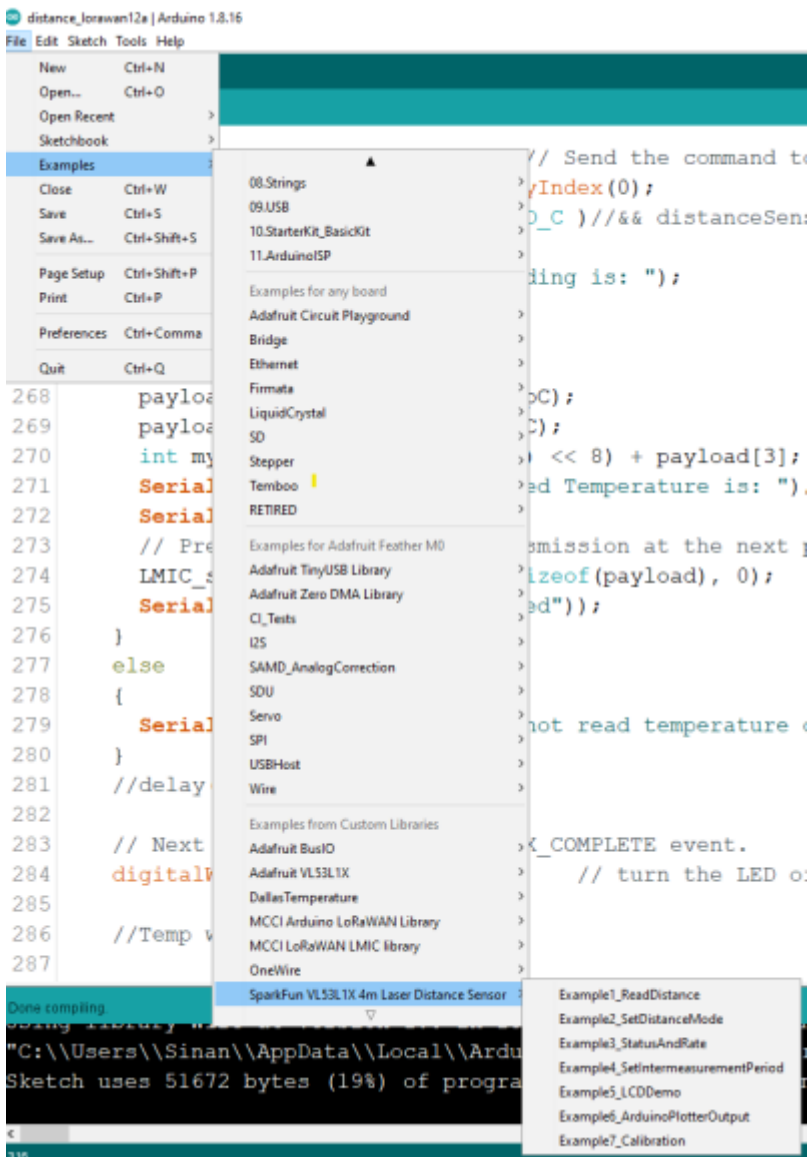

Figure 10: How to open the examples

4.1.3 Embedded programming

At the beginning of the script the previously defined keys must be specified, because without these keys no authentication is possible. OTAA was explained in detail at the beginning of the documentation, so parts of the code that deal with activation are only briefly mentioned.

```

57 static const ul_t PROGMEM APPEUI[8] = { 0x00, 0x00, 0x00, 0x00, 0x00, 0x00, 0x00, 0x00 };
58 void os_getArtEui (ul_t* buf) {
59   memcpy_P(buf, APPEUI, 8);
60 }
61
62 // This should also be in little endian format, see above.
63 static const ul_t PROGMEM DEVEUI[8] = { 0x6E, 0x99, 0x04, 0x00, 0x7E, 0x05, 0xB3, 0x70 };
64 void os_getDevEui (ul_t* buf) {
65   memcpy_P(buf, DEVEUI, 8);
66 }
67
68 // This key should be in big endian format (or, since it is not really a
69 // number but a block of memory, endianness does not really apply). In
70 // practice, a key taken from ttnctl can be copied as-is.
71 static const ul_t PROGMEM APPKEY[16] = { 0x7E, 0xD1, 0x1E, 0x88, 0x3D, 0x8A, 0x85, 0x2A, 0xCC, 0x74, 0x2D, 0x88, 0x06, 0x01, 0x67, 0x43 };
72 void os_getDevKey (ul_t* buf) {
73   memcpy_P(buf, APPKEY, 16);
74 }

```

Figure 11: Implementation of the keys

Most of the important things happen in the `do_send`, `onEvent` and `setup` functions. "setup" is used to test whether the distance sensor is available and initialize LMIC.

```

290 void setup() {
291
292   Wire.begin();
293
294   Serial.begin(9600); //115200
295   Serial.println("VL53L1X Qwiic Test");
296
297   if (distanceSensor.begin() != 0) //Begin returns 0 on a good init
298   {
299     Serial.println("Sensor failed to begin. Please check wiring. Freezing...");
300     while (1)
301       ;
302   }
303   Serial.println("Sensor online!");
304
305   // LMIC init
306   os_init();
307   // Reset the MAC state. Session and pending data transfers will be discarded.
308   LMIC_reset();
309   //LMIC_setLinkCheckMode(0);
310   //LMIC.dn2Dr = DR_SF9;
311   LMIC_setClockError(MAX_CLOCK_ERROR * 1 / 100);
312   // Start job (sending automatically starts OTAA too)
313   do_send(&sendjob);
314 }

```

Figure 12: setup function

The `do_send` function is the most relevant function because the data for transmission in ttn are prepared there. All measured values are received there and prepared as bytes for sending. If no transmission is currently running, distance data is retrieved and stored as byte.

```

void do_send(osjob_t* j) {
  //digitalWrite(LED_BUILTIN, HIGH); // turn the LED on (HIGH is the voltage level)
  // Check if there is not a current TX/RX job running
  if (LMIC.opmode & OP_TXRXPEND) {
    Serial.println(F("OP_TXRXPEND, not sending"));
  } else {
    //distance sensor
    distanceSensor.startRanging(); //Write configuration bytes to initiate measurement
    while (!distanceSensor.checkForDataReady())
    {
      delay(1);
    }
    int distance = distanceSensor.getDistance(); //Get the result of the measurement from the sensor
    distanceSensor.clearInterrupt();
    distanceSensor.stopRanging();

    Serial.print("Distance(mm): ");
    Serial.print(distance);

    float distanceInches = distance * 0.0393701;
    float distanceFeet = distanceInches / 12.0;

    Serial.print("\tDistance(ft): ");
    Serial.print(distanceFeet, 2);
    //added
    byte payload[4];
    payload[0] = highByte(distance);
    payload[1] = lowByte(distance);

```

Figure 13: get distance and store as byte

The same principal is applied to the temperature data. Here you have to take care that the temperature is integer, therefore the temperature is multiplied by 100.

```

:60 sensors.requestTemperatures(); // Send the command to get temperatures
:61 float tempC = sensors.getTempCByIndex(0);
:62 if (tempC != DEVICE_DISCONNECTED_C) //&& distanceSensor.begin() == 0
:63 {
:64     Serial.print("Temperature reading is: ");
:65     Serial.println(tempC);
:66     int tempTempC = tempC * 100;
:67     //byte payload[2];
:68     payload[2] = highByte(tempTempC);
:69     payload[3] = lowByte(tempTempC);
:70     int myVal = ((int)(payload[2]) << 8) + payload[3];
:71     Serial.print("Decoded & Encoded Temperature is: ");
:72     Serial.println(myVal);
:73     // Prepare upstream data transmission at the next possible time.
:74     LMIC_setTxData2(1, payload, sizeof(payload), 0);
:75     Serial.println(F("Packet queued"));
:76 }

```

Figure 14: get temperature and store as byte

“onEvent” reacts on different events that can occur. For example it is used to handle events that are relevant for the authentication and activation of the device.

After the data has entered the ttn via an uplink message, the high and low bytes must be decoded so that both the high byte and the low byte are in the correct position. Furthermore the temperature has to be calculated again to a decimal number by dividing by 100.

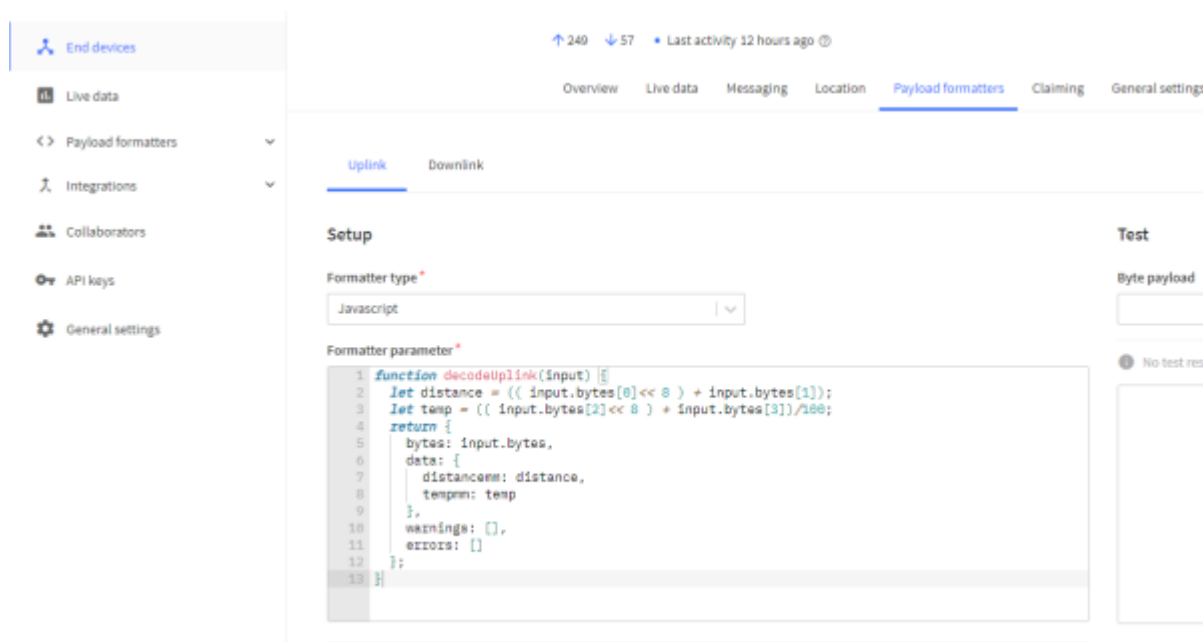

Figure 15: Decoding

The incoming data is then displayed in the “Live data” section.



Time	Entity ID	Type	Data preview
2024-07-10 10:41:10	eu1-7062027e00009904	Forwarded LoRaWAN data message	
2024-07-10 10:41:10	eu1-7062027e00009904	Forwarded LoRaWAN data message	
2024-07-10 10:41:10	eu1-7062027e00009904	Forwarded LoRaWAN data message	
2024-07-10 10:41:10	eu1-7062027e00009904	Forwarded LoRaWAN data message	
2024-07-10 10:41:10	eu1-7062027e00009904	Forwarded LoRaWAN data message	

Figure 16: Select live data

The pin configuration to ensure a successful SPI communication between the microcontroller and the Lora module must be done exactly as shown in the next picture.

```

82
83 // Pin mapping
84 const lmic_pinmap lmic_pins = {
85     .nss = 8,
86     .rxtx = LMIC_UNUSED_PIN,
87     .rst = 4,
88     .dio = {3, 6, LMIC_UNUSED_PIN},
89     .rxtx_rx_active = 0,
90     .rssi_cal = 8, // LBT
91     .spi_freq = 8000000,
92 };
93

```

Figure 17: Pin configuration

4.2 Implementation in Node-Red

4.2.1 "Theoretical" test with 3 gateways

The entire flow starts with an injection node which contains a payload consisting of a file which was created by TTN. The only difference is that for testing purposes several gateways were added to the file.



Figure 18: Test data

The first gateway is the gateway from the original message, all other gateways and their ids were made up to test the entire flow and database. The initial injection node containing the modified json file has five connections to other nodes.

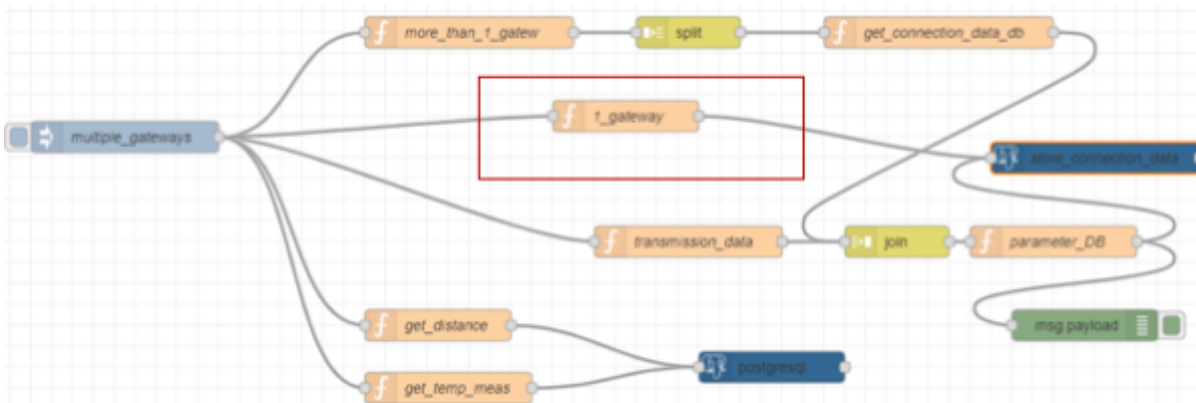

Figure 19: Flow for “one” gateway

The simplest case is that a message is only received from one gateway. In this case the function “1_gateway” contains all gateway and connection data.

Name: 1_gateway

Setup Start Funktion Stopp

```

1
2 - if(msg.payload.uplink_message.rx_metadata.length == 1){
3
4   var msg_id = "03"//msg._msgid;
5   var gateway_id=msg.payload.uplink_message.rx_metadata[0].gateway_ids.gateway_id;
6   var gateway_eui = msg.payload.uplink_message.rx_metadata[0].gateway_ids.eui;
7   var rssi = msg.payload.uplink_message.rx_metadata[0].rssi;
8   var channel_rssi = msg.payload.uplink_message.rx_metadata[0].channel_rssi;
9   var snr = msg.payload.uplink_message.rx_metadata[0].snr;
10
11  var bandwidth = msg.payload.uplink_message.settings.data_rate.lora.bandwidth;
12  var spre_factor = msg.payload.uplink_message.settings.data_rate.lora.spreading_factor;
13  var code_rate = msg.payload.uplink_message.settings.coding_rate;
14  var air_time = msg.payload.uplink_message.consumed_airtime;
15  var topic = "v3/+/devices/+/up"//msg.topic;
16
17  msg.params = [msg_id,gateway_id,gateway_eui,rssi,channel_rssi,snr,bandwidth,spre_factor,code_rate,air_time,topic];
18  msg.topic = "connection";
19  return msg;
20 }
21 else{
22   msg = null;
23   return msg;
24 }
25 }

```

Figure 20: Function 1_gateway

These parameters are extracted individually from the payload and assigned to new variables. This happens only if the array “msg.payload.uplink.rx_metadata” has the length one, i.e. contains only one gateway. If more gateways are contained, msg is initialized with null and nothing is stored in the database. The newly set variables are stored in “msg.params”. “msg.params” contains the parameters which will be used in the following postgresql-node.

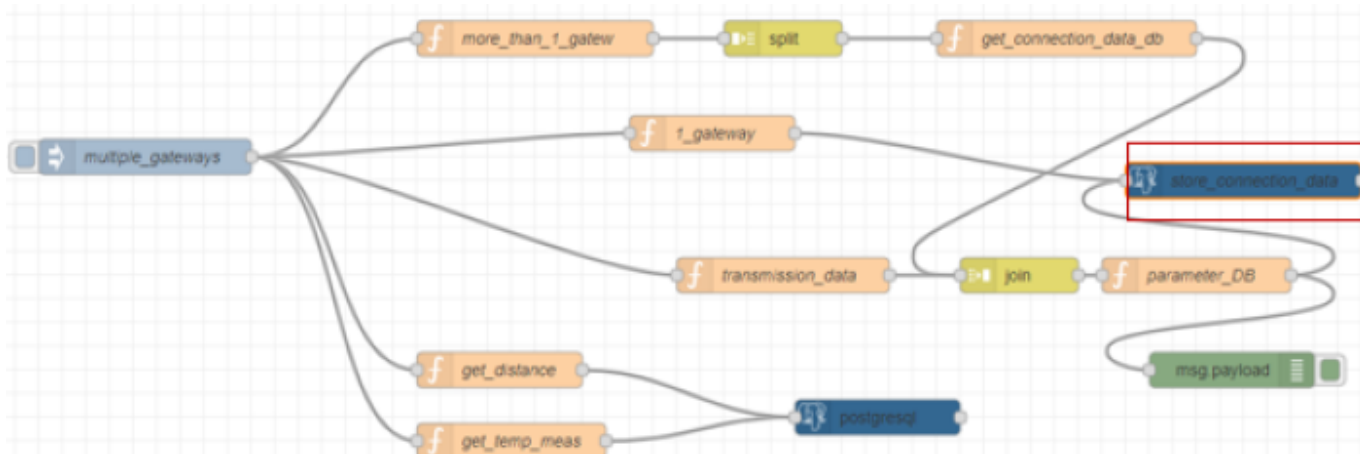

Figure 21: Store connection data

The set parameters are the input for the insert statement within the node.

Name

Server

Split results in multiple messages

Number of rows per message

Query

```
1 Insert into ta_connection values($1,$2,$3,$4,$5,$6,$7,$8,$9,$10,$11);
```

Figure 22: Insert statement with the necessary parameters

This saves the previously defined values in the database in the table “ta_connection”. For the postgresql node some settings must be made so that the database can be used.

The image shows two screenshots of a database configuration interface. The top screenshot displays the 'Connection' tab with the following settings: Name: PB; Host: hsrw.space; Port: 5432; Database: emrp2021; SSL: false. The bottom screenshot displays the 'Security' tab with the following settings: Name: PB; User: emrp2021_master; Password: [redacted].

Figure 23: Settings for the database

Firstly, the host and the database used must be specified. Also, the database user and the password of the database must be specified. However, it should be noted that if one postgresql node is changed then all postgresql nodes are automatically changed. The measured values for the distance and the temperature are extracted by the nodes “get_distance” and “get_temp_meas” from the payload of the initial json file.

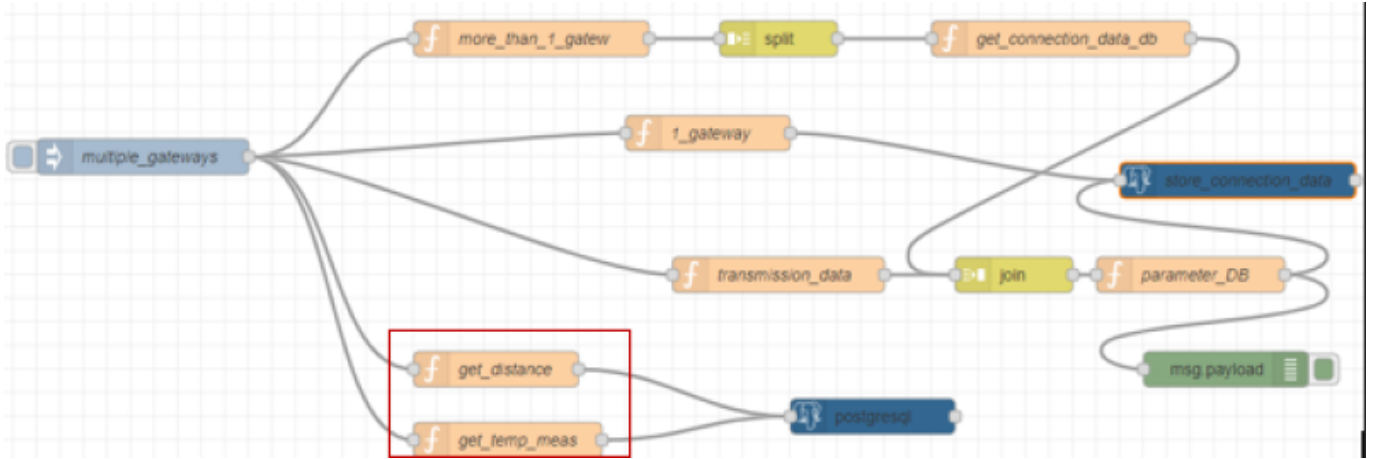

Figure 24: Functions to extract data for the measurement tables

Both functions are designed to extract data only if measured values are available, otherwise msg is set to zero.

```
Name: get_distance

1- if (typeof msg.payload.uplink_message.decoded_payload.distancecm != 'undefined' && msg.payload.uplink_message.decoded_payload.distancecm != null){
2 var dev_eui = msg.payload.end_device_ids.dev_eui;
3 var time = msg.payload.uplink_message.rx_metadata[0].time;
4 var channel = "distance";
5 var topic = msg.topic;
6 var app_id = msg.payload.end_device_ids.application_ids.application_id;
7 var measurement = msg.payload.uplink_message.decoded_payload.distancecm;
8
9 msg.params = [ dev_eui,time,channel,topic,app_id,measurement ];
10- return msg;}
11
12- else{
13   msg = null;
14   return msg;
15- }
```

Figure 25: Details for get_distance

Similar to the example before, the necessary parts of the payload are extracted here and set as parameters for the following query. This was illustrated for “get_distance” in the figure but the same principle can be found in “get_temp_meas”. However, transferred json files that have multiple gateways are a bit more complicated. The function “more_than_1_gateway” checks if the object contains more than one gateway and initializes the payload with the object for the gateways. If not, msg is initialized with null.

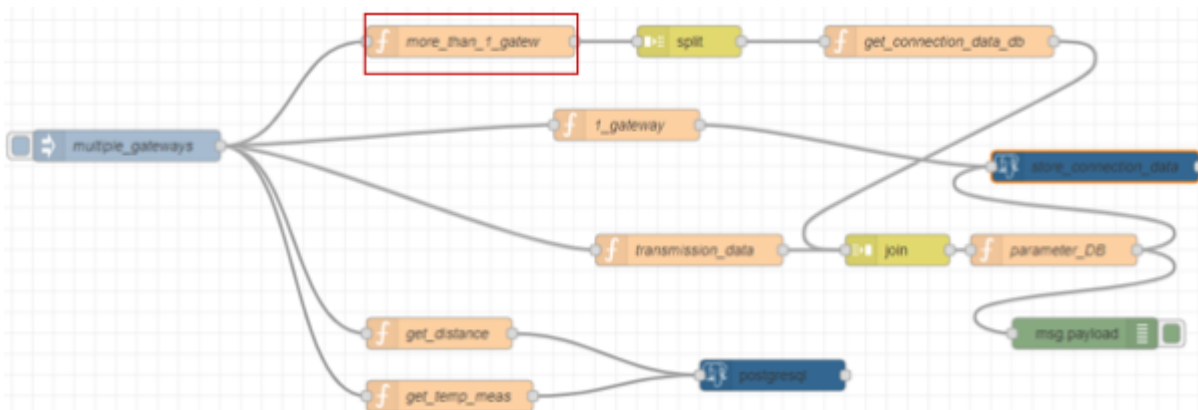

Figure 26: Function node to handle more than one gateway

Name: more_than_1_gatew

Setup Start Funktion Stopp

```
1
2 if(msg.payload.uplink_message.rx_metadata.length>1){
3   msg.payload = msg.payload.uplink_message.rx_metadata;
4   return msg;
5 }
6 else{
7   msg = null;
8   return msg;
9
10 }
```

Figure 27: Details for "more_than_1_gatew"

The node "split" ensures that the payload is always split off as an array with the length one, so that, for example, an object containing 3 gateways is split three times into three payloads.

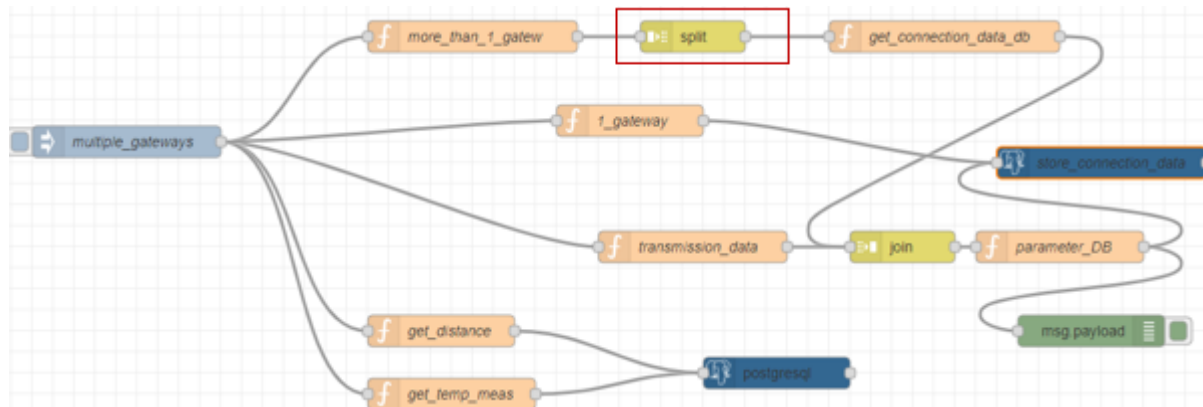

Figure 28: split node

⚙️ Eigenschaften



Aufteilung von `msg.payload` entsprechend dem Typ:

string / buffer

Aufteilung

Als Nachrichtenstrom behandeln (Streaming-Modus)

array

Aufteilung

object

Sende eine Nachricht für jedes Schlüssel/Wert-Paar

Schlüssel kopieren zu

🔑 Name

|

Figure 29: Details for the split node

After that each payload is forwarded in the flow to the function “get_connection_data_db”. There the relevant parts of the split objects are extracted and stored in the payload as an array. It is important that “msg.topic” is also provided with a unique value. This will be important for the next join node.

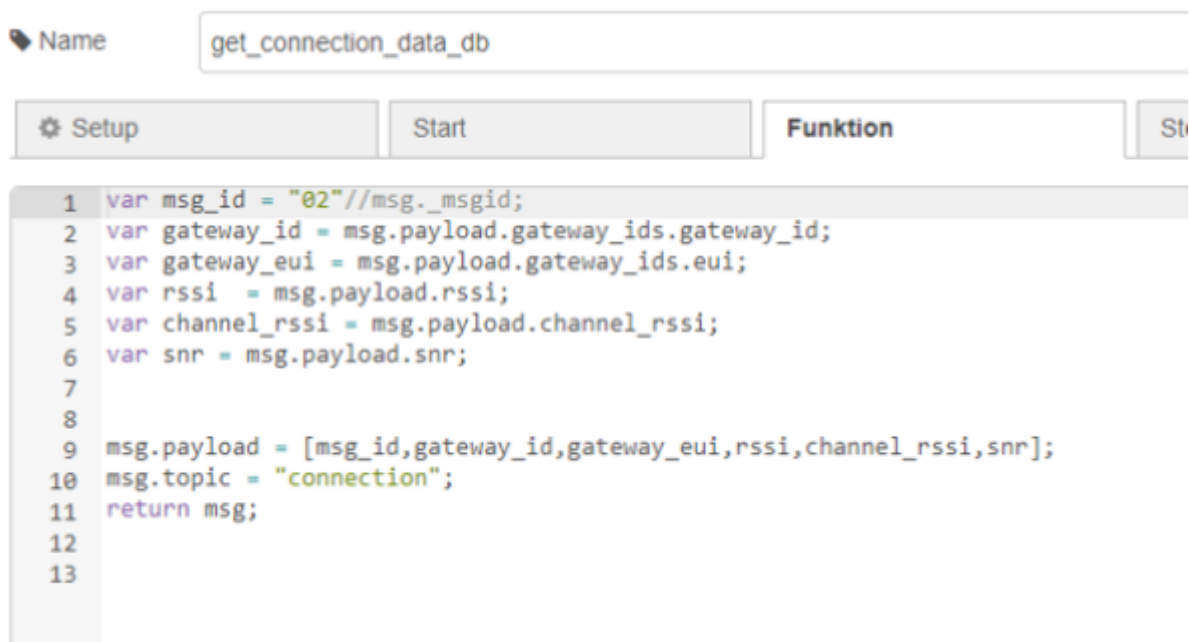

The screenshot shows a function editor interface. At the top, there is a search bar with the text 'get_connection_data_db'. Below it are three tabs: 'Setup', 'Start', and 'Funktion'. The 'Funktion' tab is active, displaying the following code:

```
1 var msg_id = "02"//msg._msgid;
2 var gateway_id = msg.payload.gateway_ids.gateway_id;
3 var gateway_eui = msg.payload.gateway_ids.eui;
4 var rssi = msg.payload.rssi;
5 var channel_rssi = msg.payload.channel_rssi;
6 var snr = msg.payload.snr;
7
8
9 msg.payload = [msg_id,gateway_id,gateway_eui,rssi,channel_rssi,snr];
10 msg.topic = "connection";
11 return msg;
12
13
```

Figure 30: Details for the function "get_connection_data"

In the join node, the gateways are combined with the connection data. This results in data sets with the same connection data but different gateway information. With the use of the join Node is to be considered that the individual message parts must set in each case unique msg.topics before and that with the properties of the join Node the number of the message parts is specified and also the hook "and with each following message" is set. If this is not done the join node may not be able to process more than 2 separate gateway information. All joined data will be stored as a value object.

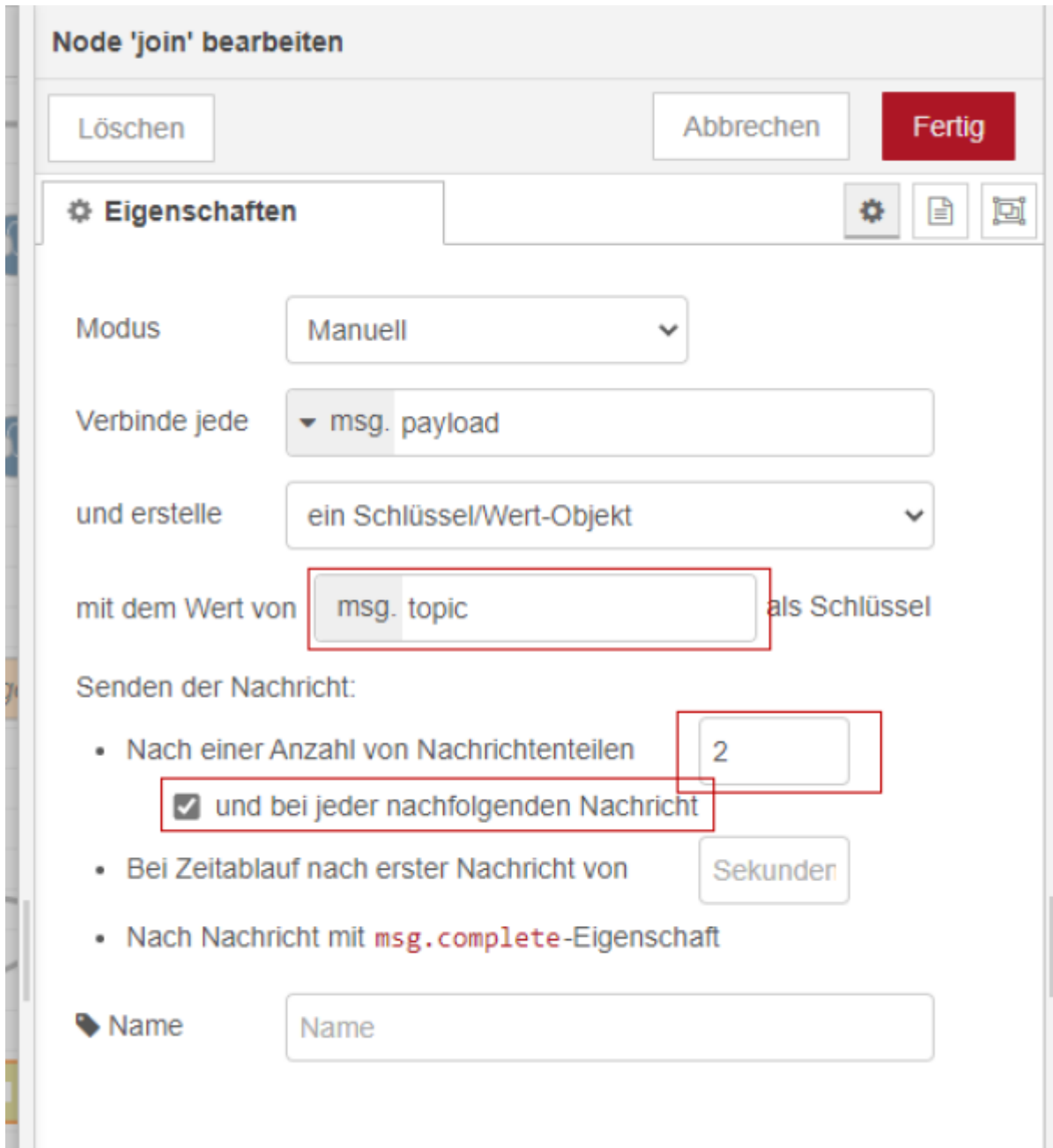

Figure 31: Properties of the join node

Then the function "parameter_DB" is used to extract all values from the merged object. For this the msg.topics "connection" and "transmission" defined before are used.

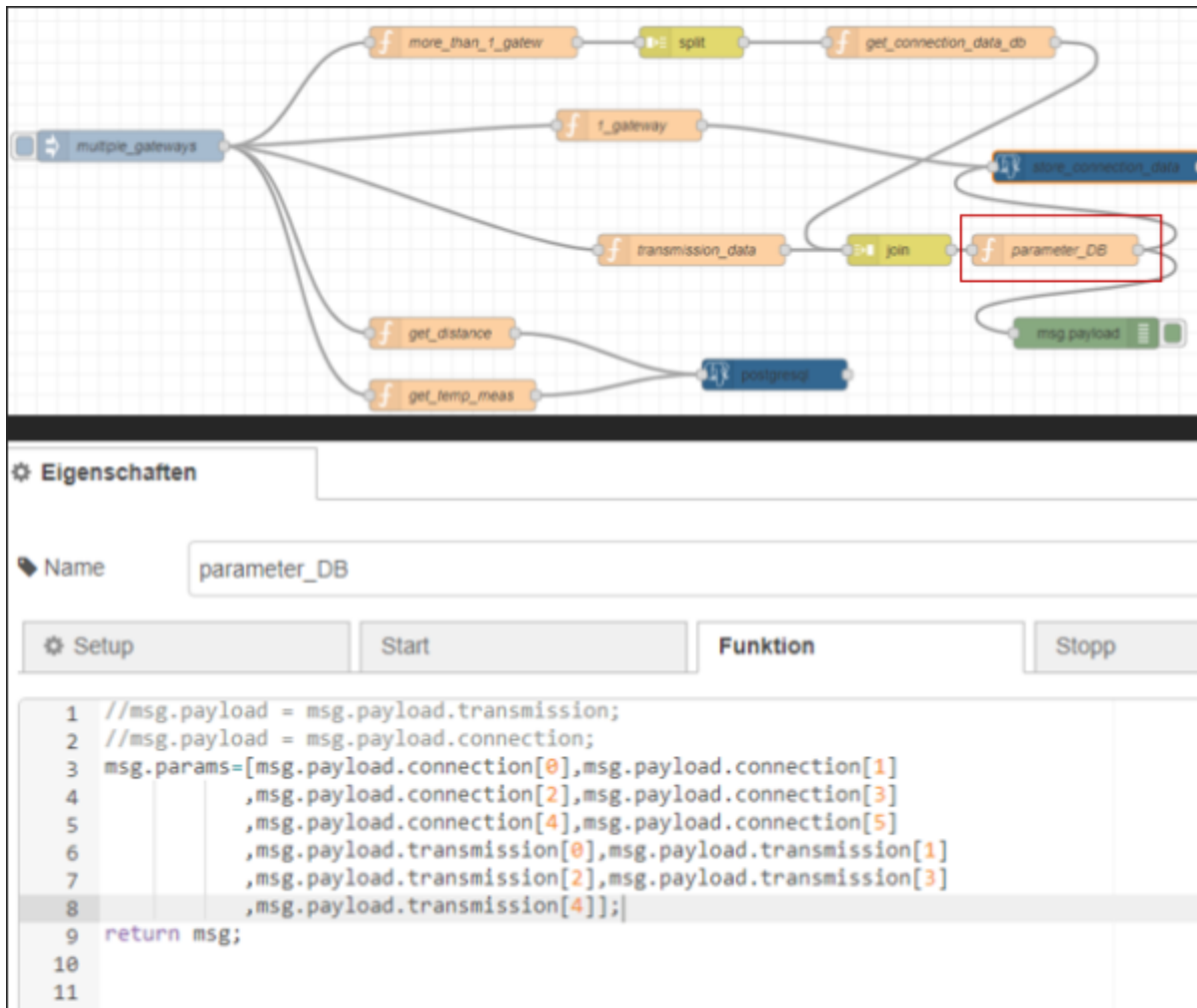

Figure 32: Parameters based on the topics connection and transmission

At the end, the defined parameters from `msg.params` are inserted into the insert-statement. It is important to note that the number of times the query is executed after the initial injection depends on how many gateways were split from the initial object. For example, if three gateways were split from the object then the query will also be filled three times with different parameters for the gateways.

The image shows a workflow editor interface. At the top, a workflow diagram is visible with several nodes: 'multiple_gateways', 'more_than_1_gatew', 'split', 'get_connection_data_db', '1_gateway', 'transmission_data', 'join', 'parameter_DB', 'msg payload', 'get_distance', 'get_temp_meas', and 'postgresql'. A red box highlights the 'store_connection_data' node. Below the diagram is a configuration panel for the 'postgresql' node, titled 'Node 'postgresql' bearbeiten'. It includes buttons for 'Löschen', 'Abbrechen', and 'Fertig'. The 'Eigenschaften' section contains the following fields: 'Name' (store_connection_data), 'Server' (PB), 'Split results in multiple messages' (unchecked), 'Number of rows per message' (1), and 'Query' (Insert into ta_connection values(\$1,\$2,\$3,\$4,\$5,\$6,\$7,\$8,\$9,\$10,\$11);).

Figure 33: Insert statement

4.2.2 real prototype

The real prototype is quite similar to the test example. But it is not using an injection node anymore.

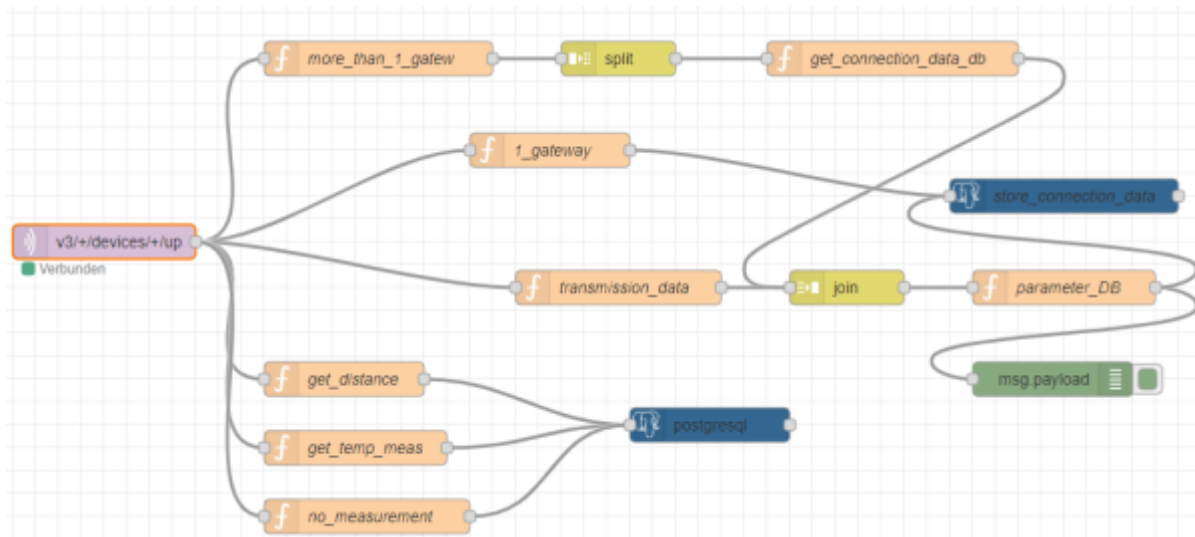

Figure 34: Prototyp

Instead a “mqtt in” node is used which receives the data from ttn.

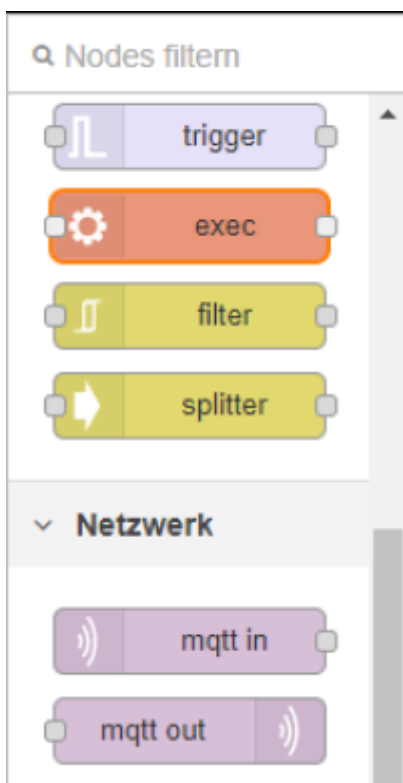

Figure 35: MQTT in node

To send a message via MQTT from ttn to Node-Red, the MQTT server of ttn must be used. For this, an API key must be created in ttn. MQTT configuration can be accessed via “Integrations”.

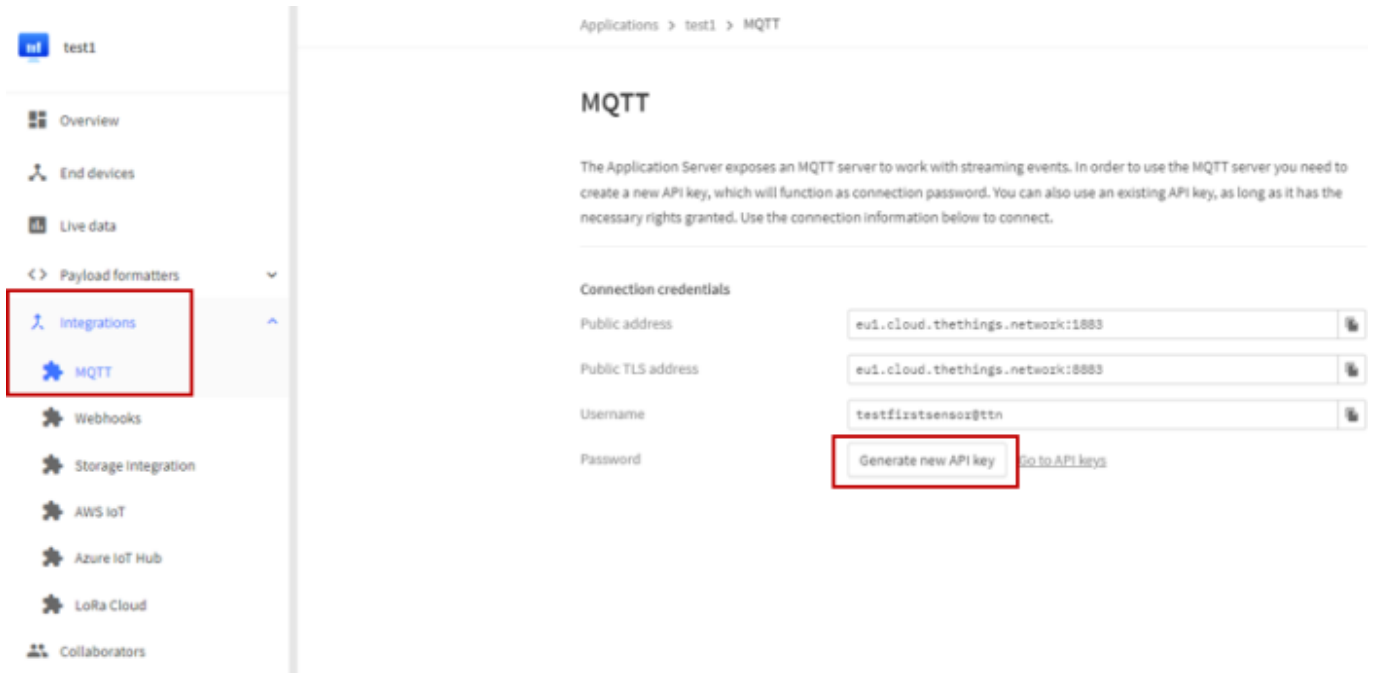

Figure 36: How to generate API key for MQTT

After that “Generate new API key” can be clicked to generate a new key. This allows to use the MQTT server. From the last figure, the server and the port can also be copied from the field “Public address” and can be put within the properties of the MQTT Node. Also the used protocol must be specified within the properties in our case it is “MQTT V3.1.1”.

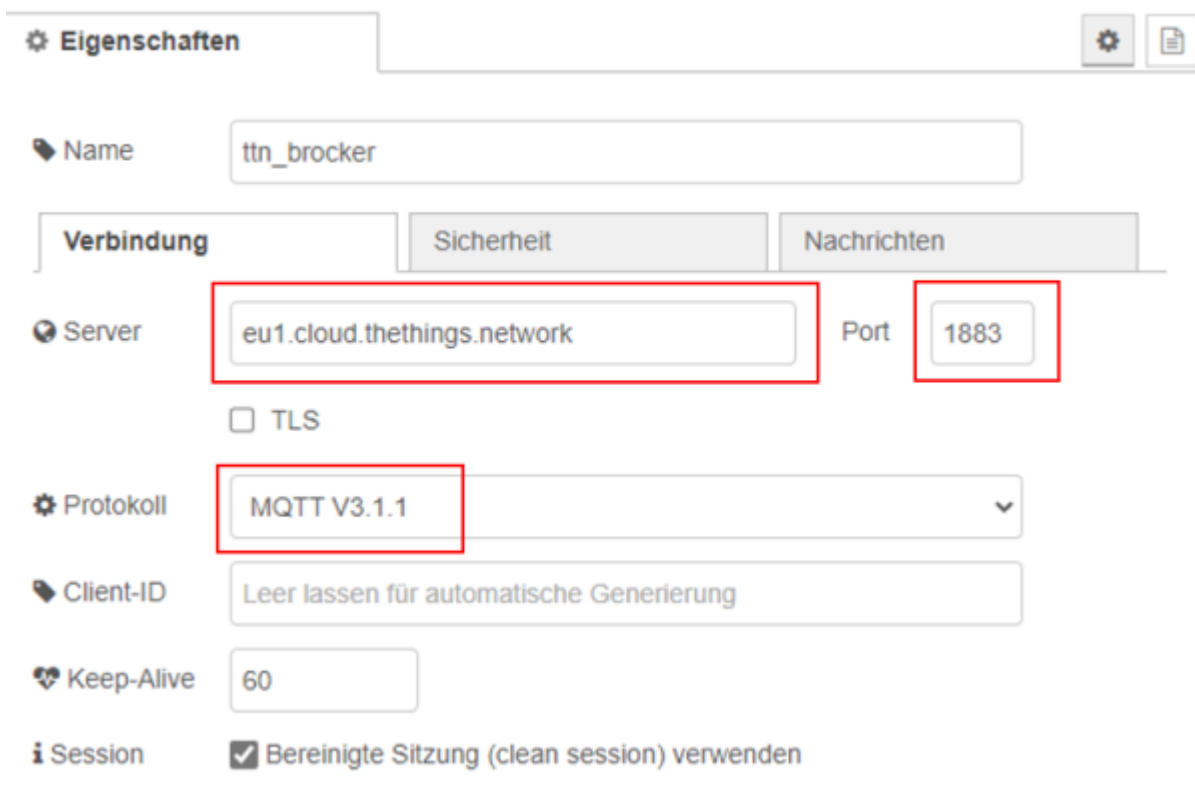



Figure 37: connection parameters

Furthermore, both the generated API key as password and additionally the username have to be provided. Both can be seen for example in figure 35 for this project and have to be added to the properties of MQTT node.

Node 'mqtt in' bearbeiten > **Node 'mqtt-broker' bearbeiten**

Löschen Abbrechen **Aktualisieren**

Eigenschaften  

Name

Verbindung **Sicherheit** Nachrichten

Benutzername

Passwort

Figure 38: integration of password and username

The only part that is missing is the implementation of the topic to retrieve messages from the uplink traffic. The topic used is a topic provided by the MQTT server. Wildcards are used for the `application_id` and the `device_id`. This allows Node Red to receive messages not only from one device. Furthermore, json object must be selected as output.

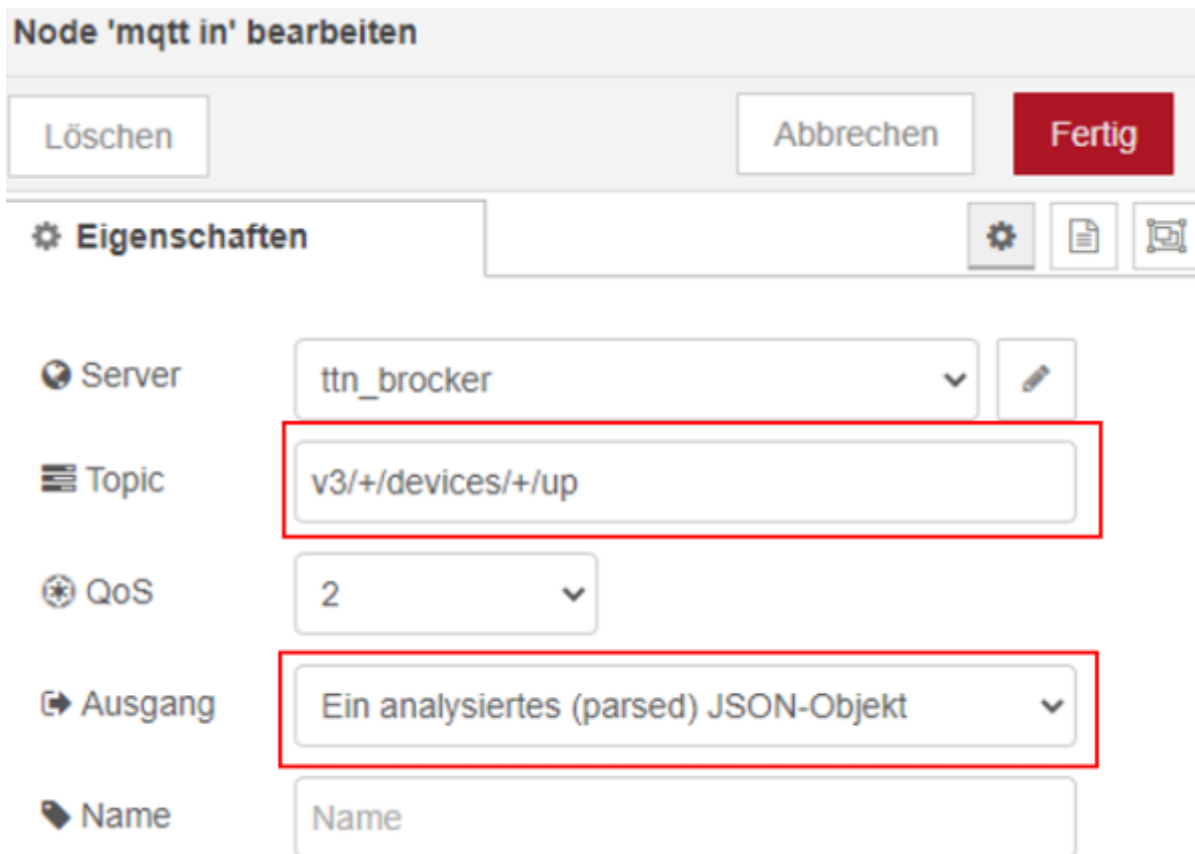

Figure 39: Set output and right output

4.3 Datamodel

4.3.1 Tables

The database we use consists of static and dynamic tables.

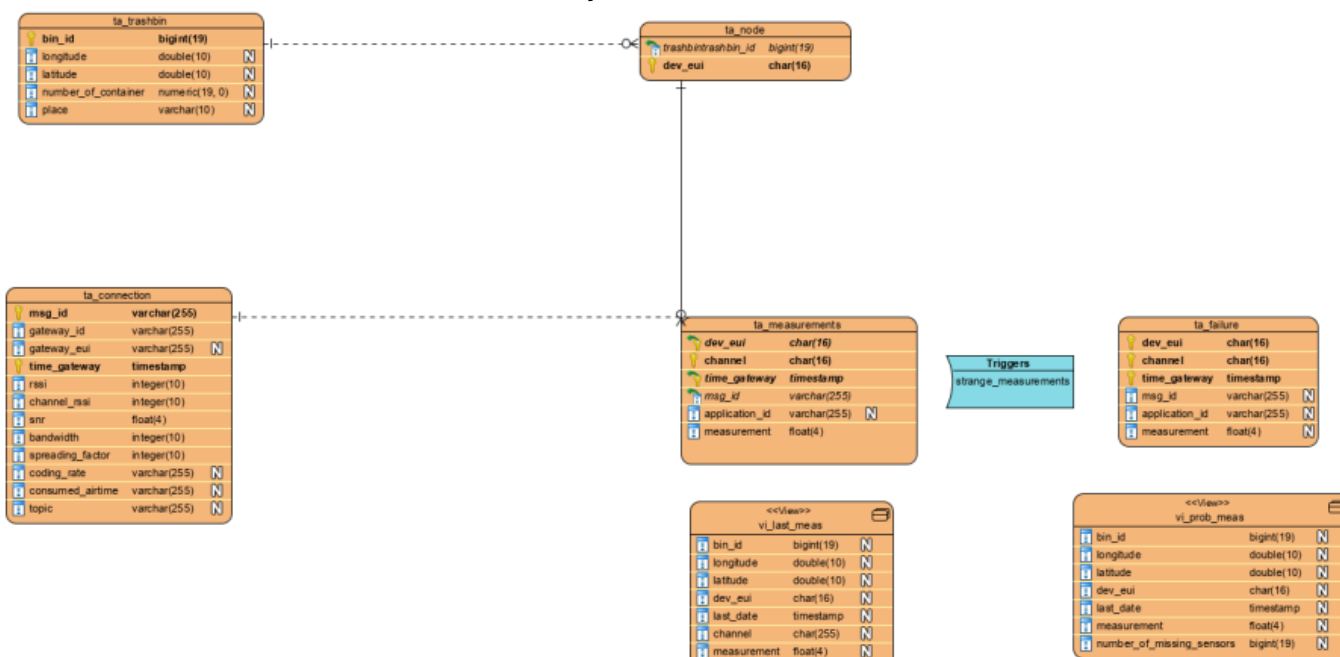

Figure 40: Used tables and views

Among the static tables, we have, among others, the table “ta_trashbin”, which stores all trash bins, their location, number of containers, and the city in which they are located. “bin_id” acts as the primary key for this table.

```

1 SELECT bin_id, latitude, longitude, number_of_container, place
2 FROM public.trashbin;

```

Data Output Explain Messages Notifications

	bin_id [PK] bigint	latitude double precision	longitude double precision	number_of_container numeric	place text
1	200000402	51.41055037	6.584027857		1 Moers
2	200001443	51.41388008	6.583538186		1 Moers
3	200001526	51.40912285	6.591295972		1 Moers
4	200001439	51.41414646	6.58943519		1 Moers
5	200001440	51.41527005	6.589190606		1 Moers
6	200001441	51.41563886	6.589281969		1 Moers
7	200001436	51.42117812	6.585614551		1 Moers
8	200000399	51.41945011	6.591256745		1 Moers
9	200001432	51.4212601	6.588204056		1 Moers
10	200001433	51.4211679	6.588633545		1 Moers
11	200001434	51.42098693	6.588387201		1 Moers
12	200001435	51.42090152	6.588645028		1 Moers
13	200001437	51.42043029	6.588135744		1 Moers

Figure 41: Table for the trashbins

The other static table is “ta_node”. This stores all active devices and their associated trash bins. “dev_eui” is the primary key and “bin_id” is the foreign key of the table. The table must be updated every time when a new device is attached to a trash bin. Otherwise, no new measured values can be stored.

```
1 SELECT dev_eui, bin_id
2 FROM public.node;
```

Data Output Explain Messages |

	dev_eui [PK] character (16)	bin_id bigint
1	70B3D57ED004996E	200000402

Figure 41: Table for the node

To the dynamic tables, which are filled by new measured values, belongs "ta_measurement". This contains only the measured values for the respective sensors. The primary key consists of the columns "dev_eui", "time_gateway" and "channel". Channel indicates which measurement type is present.

```
1 SELECT dev_eui, time_gateway, channel, msg_id, application_id, measurement
2 FROM public.ta_measurement;
```

Data Output Explain Messages Notifications

	dev_eui [PK] character (16)	time_gateway [PK] timestamp with time zone	channel [PK] character (16)	msg_id character (16)	application_id text	measurement real
--	--------------------------------	---	--------------------------------	--------------------------	------------------------	---------------------

Figure 42: Table "ta_measurement"

The next dynamic table is "ta_connection". This uses the "msg_id" and "time_gateway" as primary keys. The table consists of columns that refer to the respective gateway (gateway_id, gateway_eui, rssi, channel_rssi, snr, time_gateway) and the other columns refer to the transmission of the data.

```

1 SELECT msg_id, gateway_id, gateway_eui, rssi, channel_rssi, snr,
2        bandwidth, spreading_factor, coding_rate, consumed_airtime, topic,
3        time_gateway
4 FROM public.ta_connection;

```

msg_id	gateway_id	gateway_eui	rssi	channel_rssi	snr	bandwidth	spreading_factor	coding_rate	consumed_airtime	topic	time_gateway
[PK] character (16)	[PK] text	text	integer	integer	real	integer	integer	character (3)	character (3)	text	Timestamp with time zone

Figure 43: Table “ta_connection”

4.3.2 Views and Trigger

“ta_failure” is a table that is structured in the same way as “ta_measurement”. It is also indirectly filled by “ta_measurement” by using an insert trigger. This stores questionable new records also into the “ta_failure” table. Beside the tables there are also two views which serve as bases for Dash Plotly. “vi_last_meas” has the last measurement for each microcontroller.

```

CREATE OR REPLACE VIEW public.vi_last_meas
AS
WITH last_meas AS (
    SELECT ta_measurement.dev_eui,
           max(ta_measurement.time_gateway) AS last_date
    FROM ta_measurement
    WHERE ta_measurement.channel = 'distance'::bpchar
    GROUP BY ta_measurement.dev_eui, ta_measurement.channel
)
SELECT tb.bin_id,
       tb.longitude,
       tb.latitude,
       last_meas.dev_eui,
       last_meas.last_date,
       tm.channel,
       tm.measurement
FROM ta_measurement tm
JOIN last_meas ON last_meas.dev_eui = tm.dev_eui AND last_meas.last_date = tm.time_gateway
JOIN ta_node nd ON last_meas.dev_eui = nd.dev_eui
JOIN ta_trashbin tb ON nd.bin_id = tb.bin_id
WHERE tm.channel = 'distance'::bpchar;

```

Figure 44: View “vi_last_meas”

“vi_prob_meas” has the latest problematic record for the microcontrollers. In case of missing sensor measurements, the number of missing measurements is displayed in the last column.

```

CREATE OR REPLACE VIEW public.vi_prob_meas
AS
with last_meas_pro_channel as(
SELECT nd.bin_id,
      ( SELECT ta_trashbin.longitude
        FROM ta_trashbin
        WHERE ta_trashbin.bin_id = nd.bin_id) AS longitude,
      ( SELECT ta_trashbin.latitude
        FROM ta_trashbin
        WHERE ta_trashbin.bin_id = nd.bin_id) AS latitude,
      tf.dev_eui,
      tf.channel,
      max(tf.time_gateway) AS last_date,
      (( SELECT count(DISTINCT ta_measurement.channel) AS count
        FROM ta_measurement)) - (( SELECT count(ta_measurement.channel) AS count
        FROM ta_measurement
        WHERE ta_measurement.time_gateway = max(tf.time_gateway) AND ta_measurement.dev_eui = tf.dev_eui
        GROUP BY ta_measurement.time_gateway)) AS number_of_missing_sensors
FROM ta_failure tf
JOIN ta_node nd ON nd.dev_eui = tf.dev_eui
GROUP BY tf.dev_eui, tf.channel, nd.bin_id
Select lm.bin_id,lm.longitude
      ,lm.latitude,lm.dev_eui
      ,lm.channel,lm.last_date
      ,lm.number_of_missing_sensors, tm.measurement
      from ta_measurement tm inner join last_meas_pro_channel lm on lm.dev_eui = tm.dev_eui
                                                                and lm.last_date = tm.time_gateway
                                                                and lm.channel = tm.channel;

```

Figure 45: View “vi_prob_meas”

The trigger checks two things firstly whether the data records contain measured values, if not the data record is also written to the failure table. The next condition that is checked is whether all sensors were taken into account during the transmission of the data records. If not, the data records are written into the failure table. If new data records appear that are free of errors, the old data records are deleted from the failure table.

```

-- FUNCTION: public.update_strange_measurements()
-- DROP FUNCTION public.update_strange_measurements();

CREATE OR REPLACE FUNCTION public.update_strange_measurements()
RETURNS trigger
LANGUAGE 'plpgsql'
COST 100
VOLATILE NOT LEAKPROOF
AS $BODY$
DECLARE
sensor_count integer := (select count(distinct(channel)) from public.ta_measurement);
act_sensor_dev integer := (select count(channel) from ta_measurement where time_gateway = NEW.time_gateway and dev_eui = NEW.dev_eui group by NEW.time_gateway);
BEGIN
IF (NEW.MEASUREMENT IS NULL) THEN
Insert into public.ta_failure (dev_eui, time_gateway, channel, msg_id, application_id, measurement)
values (NEW.dev_eui, NEW.time_gateway, NEW.channel,NEW.msg_id
,NEW.application_id, NEW.measurement);

PERFORM pg_sleep(2);
elseif sensor_count>act_sensor_dev
then Insert into public.ta_failure (dev_eui, time_gateway, channel, msg_id, application_id, measurement)
values (NEW.dev_eui, NEW.time_gateway, NEW.channel,NEW.msg_id
,NEW.application_id, NEW.measurement);
END IF;

If ((NEW.MEASUREMENT IS NOT NULL)) AND (sensor_count=act_sensor_dev) THEN
Delete from public.ta_failure where dev_eui = NEW.dev_eui;
END IF;

RETURN NEW;
END;

```

Figure 46: Insert-Trigger after each insert

4.4 Dash Plotly

Plotly develops Dash and also offers a platform for writing and deploying Dash apps in an enterprise environment.

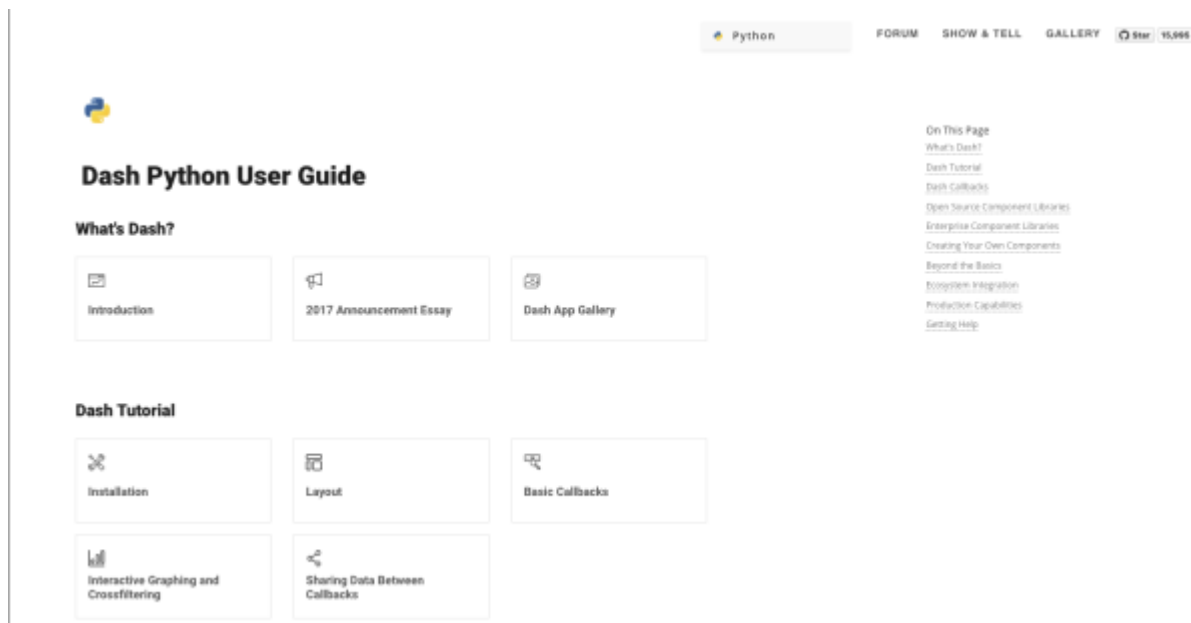

What is Dash?

- Dash is a Python framework for building web applications.
- Dash is simple enough that you can bind a user interface to your code in less than 10 minutes.
- Dash is the original low-code framework for rapidly building data apps in Python, R, Julia, and F# (experimental).

Why Dash?

- Dash is ideal for building and deploying data apps with customized user interfaces.
- It enables you to build dashboards using pure Python.
- Dash is open-source, and its apps run on the web browser.

Dash Installation

In order to start using Dash, we have to install several packages.

1. The core dash backend.
2. Dash front-end
3. Dash HTML components
4. Dash core components
5. Plotly

Dash App Layout

A Dash application is usually composed of two parts. The first part is the layout and describes what the app will look like and the second part describes the interactivity of the application. Dash provides HTML classes that enable us to generate HTML content with Python. To use these classes, we need to import `dash_core_components` and `dash_html_components`. You can also create your own custom components using Javascript and React Js.

In order to get started, we will create an app.py file in our favorite text editor, then import the packages mentioned.

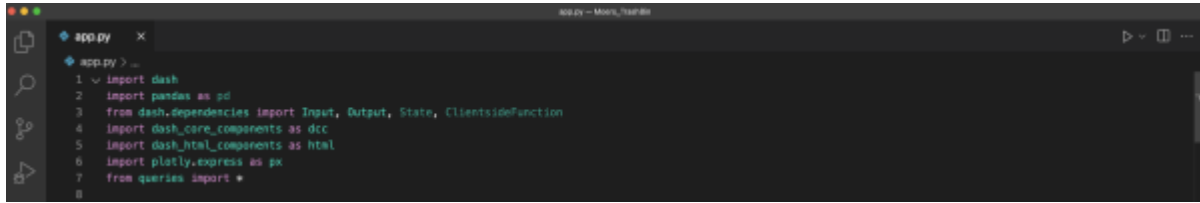

```
1 import dash
2 import pandas as pd
3 from dash.dependencies import Input, Output, State, ClientsideFunction
4 import dash_core_components as dcc
5 import dash_html_components as html
6 import plotly.express as px
7 from queries import *
```

When we initialize Dash, we call the Dash class of dash. After that is done, we create an HTML div using the Div class from dash_html_components. Dash_html_component has all HTML tags, and dash_core_components has Graph, which renders interactive data visualizations by using plotly.js. The graph is used to create graphs on our layout. Dash also allows you to style the graph by changing colors for the background and text. Graph classes expect a figure object with the data to be plotted and the layout details. If you use the style attribute and pass an object with a specific color, you can change the background and so on.

In the figure below you will see how our layout is structured and what's included.



```
app = dash.Dash(
    __name__, meta_tags=[
        {"name": "viewport", "content": "width=device-width"}],
)
app.title = "Moers Trash Bins"
server = app.server

# Create app layout
app.layout = html.Div(
    [
        html.Div(
            [html.Div(
                id="header",
                className="row flex-display",
                style={"margin-bottom": "25px"},
            ),
            html.Div(
                html.Div(
                html.Div(
                ],
            id="mainContainer",
            style={"display": "flex", "flex-direction": "column"},
        )
```

Dash apps use callback functions to update the properties of another component when an input property changes. In-Dash, any "output" can have multiple "input" components. And in our example, we are going to use multiple-input call back functions for example we had one callback function that take two inputs (intervals and data_type) and display one output as a graph output of what we have done for the trash bins measurements in Moers as you will see below in the below following figures.

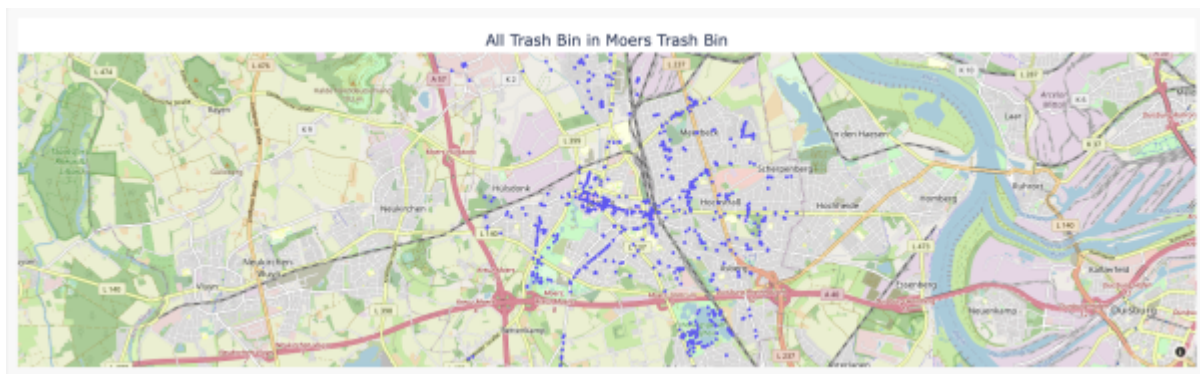

in the above figure, you will be able to see all implemented trashbin with all information about them as (location of trashbin, trashbin id)

In the below figure we display only the measurements of all actively implemented sensors upon the request of the user which is an input to the call back function that we use.

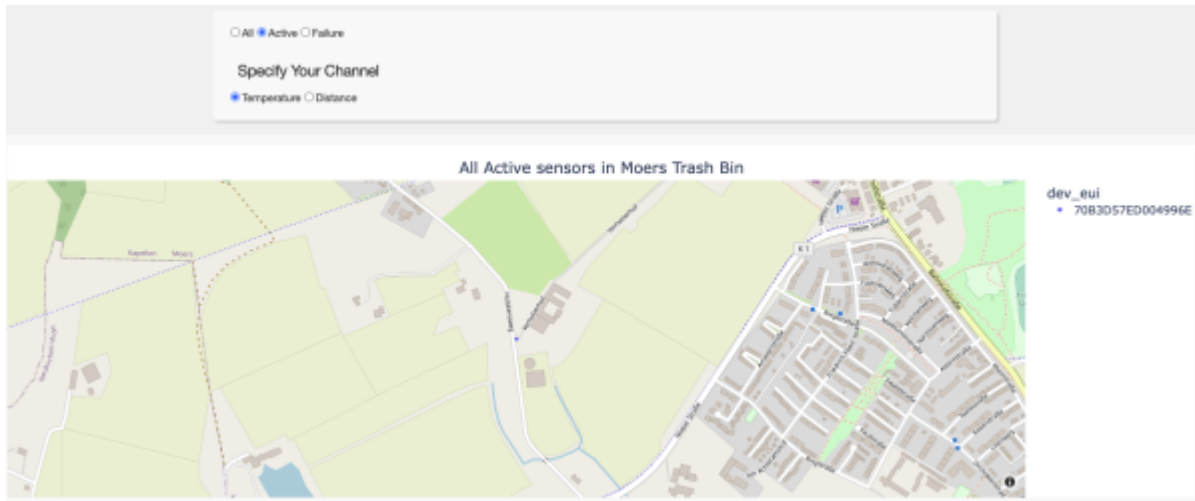

In the below figures you will show more detailed information about our project

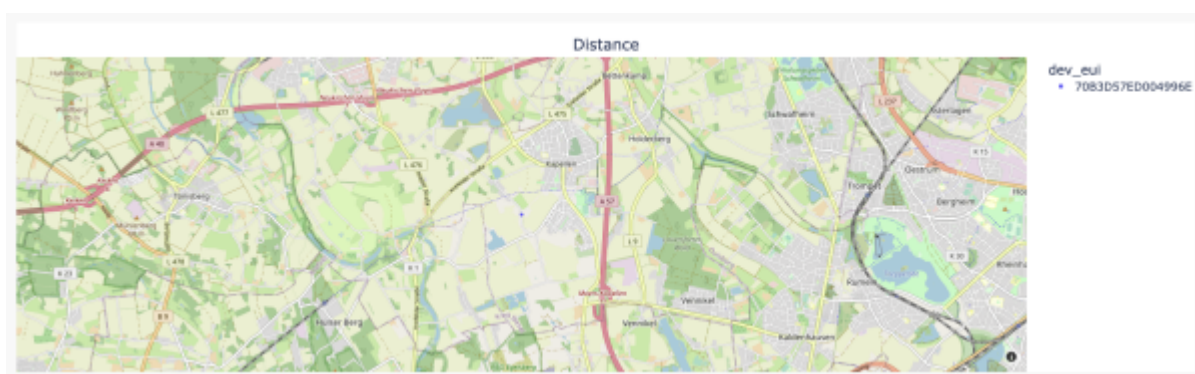
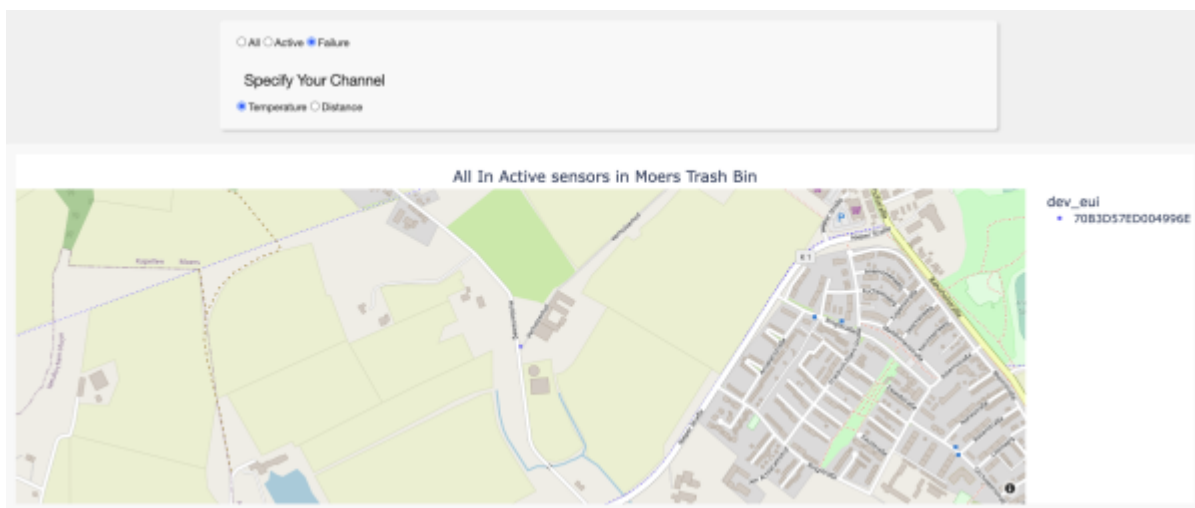

Finally, remember that Dash is built on top of Flask, so the webserver needs to be running just like Flask for us to view our visualization. We also set debug to true so no fresh server is needed every time we modify the visualization.

```
# Main
if __name__ == "__main__":
    app.run_server(debug=True)
```

For our project, this is not enough for that reason we do some extra programming stuff that allows us to grab data from the database and display it. So for that, we prepared the following queries script file which facilitates our working and allows us to be connected to our own database which is built-in progress as seen below

```
queries.py
1 import psycopg2
2 import pandas.io.sql as psql
3 import pandas as pd
4 # =====
5 # To enable everything inside queries.py file
6 from queries import *
7 # =====
8 #from logger import logger
9
10
11 # Define our connection string
12
13 conn_string = "host='hsv.space' port='5432' dbname='emrp2021' user = 'emrp2021_master' password='byqhdtyr_6L3d5'"
14 conn = psycopg2.connect(conn_string)
15 print("Connected to server")
```

then we define some functions which allow us to get needed information from the database as you will see in the figures below

```
def get_all(schema, table): # Show-Up all Trashbins and Device_id
    query = "SELECT * FROM public.trashbin ORDER BY bin_id ASC"
    case_trashbin_dev = pd.read_sqlquery(conn)
    return case_trashbin_dev

def get_active(schema, table): # Show-Up all Measurements of Active Sensor
    query = "SELECT * FROM public.vi_last_meas"
    active_meas = pd.read_sqlquery(conn)
    return active_meas

def get_failure(schema, table): # Show-Up all Measurements of In-Active Sensor
    query = "SELECT * FROM public.vi_prob_meas2 ORDER BY dev_eui ASC"
    failure_meas = pd.read_sqlquery(conn)
    return failure_meas
```

```
def get_distance(schema, table):
    query = "SELECT * FROM public.vi_last_meas2 WHERE channel = 'distance' order by last_date"
    dist = pd.read_sqlquery(conn)
    return dist

def get_temperature(schema, table):
    query = "SELECT * FROM public.vi_last_meas2 WHERE channel = 'temperature' order by last_date"
    temp = pd.read_sqlquery(conn)
    return temp
```

And now we can say that everything is done regarding the dash plotly part in our project.

5. Links and Tutorials

- Mix-Playlist about different topics: <https://www.youtube.com/playlist?list=PL2SRmCaleDVibo6IUtyKcmDCH955hqAT>
- Link for ttn: <https://www.thethingsnetwork.org/>
- SQL-Querries (Postgresql) in Node-Red: <https://flows.nodered.org/node/node-red-contrib-postgresql/in/MFnap-qr-MJE>
- TTN, MQTT Node-REd: <https://www.thethingsindustries.com/docs/integrations/mqtt/>

From:

<https://student-wiki.eolab.de/> - **HSRW EOLab Students Wiki**

Permanent link:

<https://student-wiki.eolab.de/doku.php?id=emrp2021:start&rev=1646455518>

Last update: **2023/01/05 14:38**

